

Geothermal in Oregon

Where it is being used

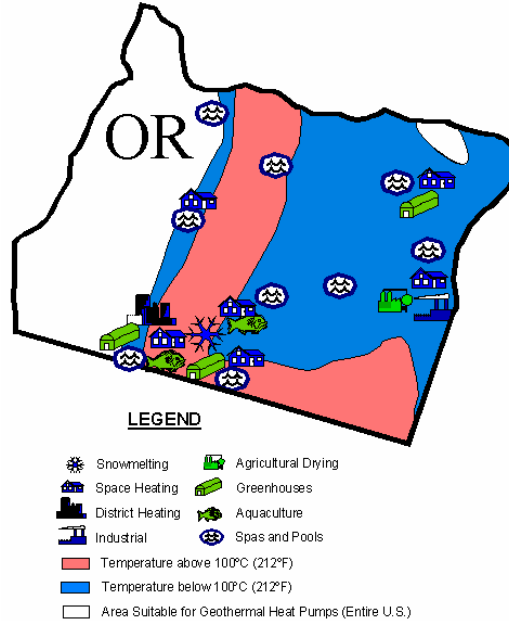

Where it can be used

Communities with Geothermal Direct-Use Development Potential

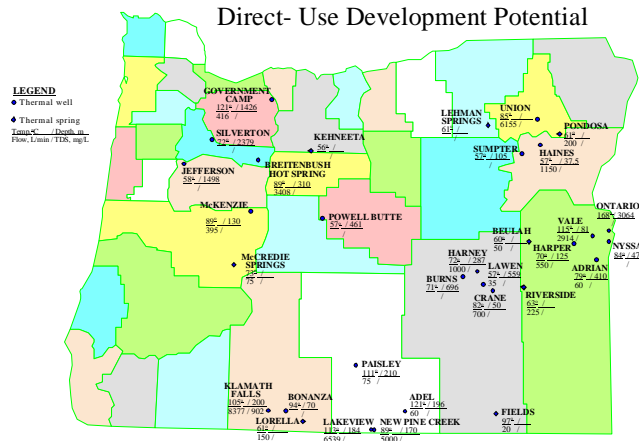

Compiled by Tonya "Toni" Boyd
 Geo-Heat Center
 Oregon Institute of Technology
 3201 Camus Drive
 Klamath Falls, OR 97601
 541-885-1750
geoheat@oit.edu

Table of Contents

This document includes general information on geothermal potential and uses in Oregon. Below is a list of the information provided in the document.

Geothermal Uses in Oregon

Possible Oregon Geothermal Power Plant Sites

Oregon Collocated Communities

Bulletin and case studies of direct-uses and heat pump operations

“Chill Out” – Oregon Institute of Technology is a Winner

The Oregon Institute of Technology Geothermal Heat System – Then and Now

Klamath Falls Geothermal District Heating System at 25 years

From Creamery to Brewery with Geothermal Energy: Klamath Basin Brewing Company

New Greenhouses in Klamath Falls

New Snow Melt Projects in Klamath Falls, OR

“Gone Fishing” Aquaculture Project – Klamath Falls, Oregon

Greenfuels of Oregon: Geothermal Energy Utilization in Biodiesel Production

Oregon Trail Mushrooms

Chiloquin Community Center – Chiloquin, Oregon

Residential Downhole Heat Exchanger – Klamath Falls, Oregon

Merle West Medical Center – Klamath Falls, Oregon

Klamath County Vandenberg Road Complex

REACH, Inc. Juniper Processing Plant - Klamath Falls, Oregon

Inn of the Seventh Mountain - Bend, Oregon







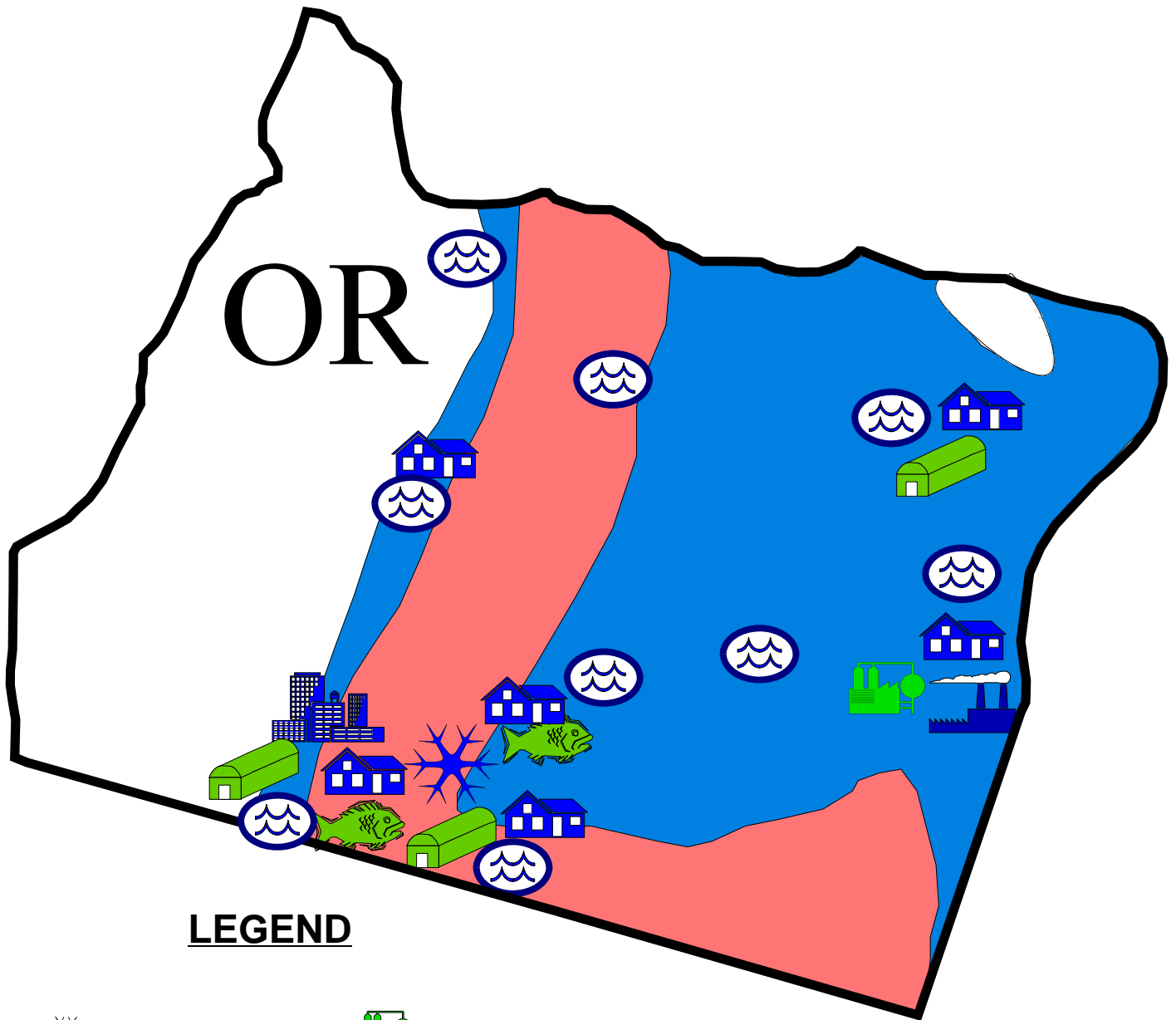

Geothermal Technologies Program Oregon Factsheet

Geo-Heat Center Publication for Oregon

Oregon Geothermal Direct-Use Projects



LEGEND

- | | | | |
|-------------------------------------------------------------------------------------|------------------|-------------------------------------------------------------------------------------|---------------------|
|  | Snowmelting |  | Agricultural Drying |
|  | Space Heating |  | Greenhouses |
|  | District Heating |  | Aquaculture |
|  | Industrial |  | Spas and Pools |

 Temperature above 100°C (212°F)

 Temperature below 100°C (212°F)

 Area Suitable for Geothermal Heat Pumps (Entire U.S.)



GEO-HEAT CENTER

Oregon Institute of Technology Klamath Falls, Oregon 97601 541/885-1750 FAX 541/885-1754

John W. Lund, Director
Tonya "Toni" Boyd
Andrew Chiasson

Geothermal Uses in Oregon

Compiled by Toni Boyd
July 2007

Oregon has been very blessed with geothermal. There are an estimated geothermal potential of 4,600 MWt for 30 yr (below 150°C) in Oregon, but only a little over 1.4 percent of that is being utilized.

A summary of the direct-uses known by the Geo-Heat Center located in Oregon is listed below. The information below contains capacity of direct-use, temperature of the resources, any information known by the author and any webpages links know at the time of this writing for each place.

Klamath Falls

Oregon Institute of Technology, Klamath Falls

District Heating

Capacity 6.2 MWt	Annual Energy Use: 13.7 GWh/yr	CO ₂ emissions saved: 10,950 tons/yr
Temperature 192°F		

Snow Melting

Capacity 0.06MWt	Annual Energy Use: 0.1 GWh/yr	CO ₂ emissions saved: 80 tons/yr
Temperature 150°F		

Currently serves all of the campus heating (650,000 sq ft), snow melting (2,500 sq ft). This heating system saves the campus approximately \$1,000,000 in heating costs per year.

The campus administration is proposing to drill a well (5,000 to 6,000 ft – 1,500 to 1,800 m) deep into a fault that is known to have a geothermal resource around 300°F (150°C), to generate electricity. If this is successful, a one megawatt (MWe) geothermal power plant of either a flash steam or binary type will be installed to provide all the electricity needs on campus. This will provide an additional savings of around \$500,000 and reduce CO₂ emissions by about 16,000 tonnes annually (compared to producing it from petroleum). The campus would then be 100% "green" by producing all of its energy needs from geothermal resources.

Bulletin Articles

"Chill Out" – Oregon Institute of Technology is a Winner

<http://geoheat.oit.edu/bulletin/bull28-2/art3.pdf>

The Oregon Institute of Technology Geothermal Heating System - Then and Now

<http://geoheat.oit.edu/bulletin/bull20-1/art3.pdf>

New Snow Melting Projects in Klamath Falls, OR

<http://geoheat.oit.edu/bulletin/bull24-3/art3.pdf>

City of Klamath Falls District Heating System

District Heating

Capacity 8.5 MWt	Annual Energy Use: 18.7 GWh/yr	CO ₂ emissions saved: 14,940 tons/yr
Temperature 210°F		

Snow Melting

Capacity 1.2 MWt	Annual Energy Use: 1.0 GWh/yr	CO ₂ emissions saved: 800 tons/yr
Temperature 125°F		

Greenhouse

Capacity: N/A Annual Energy Use: N/A CO₂ emissions saved: N/A
Temperature 199°F

Current serves process heating at the Klamath Falls wastewater treatment plant, 24 buildings (400,000 sq. ft.), greenhouses (150,000 sq. ft.)(IFA Greenhouses), snow melting (105,000 sq ft.). Expansion of the district heating system mains and development of a new sidewalk snowmelt system was undertaken in 2006 to serve the Timbermill Shores development on a former mill site. The greenhouse operation is on the City of Klamath Falls district heating system and included in the district heating numbers

Bulletin Articles

Klamath Falls Geothermal District Heating System at 25 Years

<http://geoheat.oit.edu/bulletin/bull28-2/art3.pdf>

From Creamery to Brewery with Geothermal Energy: Klamath Basin Brewing Company

<http://geoheat.oit.edu/bulletin/bull27-4/art1.pdf>

Klamath Falls Geothermal District Heating Systems

<http://geoheat.oit.edu/bulletin/bull20-1/art2.pdf>

New Snow Melting Projects in Klamath Falls, OR

<http://geoheat.oit.edu/bulletin/bull24-3/art3.pdf>

City website

<http://www.ci.klamath-falls.or.us/>

Highway De-icing

Snow Melting

Capacity 0.4 MWt Annual Energy Use: 1.8 GWh/yr CO₂ emissions saved: 1,440 tons/yr
Temperature 190°F

Bulletin article – Reconstruction of a Pavement Geothermal Deicing System

<http://geoheat.oit.edu/bulletin/bull20-1/art4.pdf>

Klamath County Vandenberg Road Complex

Space Heating

Capacity 3.1 MWt Annual Energy Use: 6.7 GWh/yr CO₂ emissions saved: 5,350 tons/yr
Temperature 151°F

The complex is on a hill top about 100 ft higher than the surrounding terrain and originally was somewhat isolated but businesses and residences are being developed nearby including the new Herald and news building. It currently services about 100,000 sq ft (Klamath County Jail, County Sheriff's Offices, Mental Health Building, Juvenile Detention and County Extension office).

Case Study

Klamath County Vandenberg Road Complex

<http://geoheat.oit.edu/bulletin/bull25-1/art2.pdf>

Herald and News

Space Heating

Capacity 0.4 MWt Annual Energy Use: 0.9 GWh/yr CO₂ emissions saved: 720 tons/yr
Temperature average 212°F

Snow Melting

Capacity 0.15 MWt Annual Energy Use: 0.3 GWh/yr CO₂ emissions saved: 240 tons/yr
Temperature average 212°F

This building is under construction and should be operational by late 2007.

Klamath Falls Residence (600)

Space Heating

Capacity 12.8 MWt Annual Energy Use: 28.0 GWh/yr CO₂ emissions saved: 22,370 tons/yr
Temperature average 185°F

Approximately 550 wells are used to heat homes in the Hot Springs and surrounding area of Klamath Falls. Most use what is referred to as a downhole heat exchanger which takes heat out of the geothermal water in a closed loop without having to

pump the well. A typical residential well can provide up to about 250,000 Btu/hr (0.1 MWt) of energy, and installations with multiple DHE, such as for schools, provide about 10 times this amount of energy. Well depths in the city vary from 100 to 1,800 feet, with 300 feet being the average. Temperatures vary from 120 to 220°F, with 140°F and above considered desirable for providing sufficient energy using a DHE.

Case Study

Residential Downhole Heat Exchanger, Klamath Falls, Oregon

<http://geoheat.oit.edu/bulletin/bull25-1/art3.pdf>

Merle West Medical Center (MWMC) Complex (Renamed Sky Lakes Medical Center)

Space Heating

Capacity 6.1 MWt Annual Energy Use: 13.7 GWh/yr CO₂ emissions saved: 10,950 tons/yr
Temperature 195°F

The original geothermal system for MWMC was designed to provide space heat and domestic hot water to the 96,000-sq ft main building; a new 56,000-sq-ft addition; the adjacent 56,000-sq ft nursing home and snow melting for the main entrance area. Since that time, the approximate areas heated have grown to include 300,000-sq-ft main building; 45,000-sq-ft medical office building; 56,000-sq-ft nursing home and a 80,000-sq-ft residential care facility (2003). The new 100,000 sq ft addition was just completed in 2007.

Case Study

Merle West Medical Center, Klamath Falls, OR

<http://geoheat.oit.edu/bulletin/bull24-2/art4.pdf>

REACH (originally Maywood Industries)

Space Heating

Capacity: 0.5 MWt Annual Energy Use: 2.4 GWh/yr CO₂ emissions saved: 1920 tons/yr
Temperature 118°F

Currently heats a 110,000 sq. ft. building and is served by a single production well, 1520 ft deep, which had a temperature of 118°F when drilled. The well was pump tested at a flow of 320 gpm with a 115 ft drawdown. The present installed capacity is about 0.5 MWt, utilizing 8.2 billion Btu/yr at a savings of \$75,000/yr (compared to natural gas).

Case Study

REACH, Inc. Juniper Processing Plant, Klamath Falls, Oregon

<http://geoheat.oit.edu/bulletin/bull25-1/art4.pdf>

Klamath Falls City Schools (6)

Space Heating

Capacity 2.6 MWt Annual Energy Use: 5.8 GWh/yr CO₂ emissions saved: 4,630 tons/yr
Temperature 180°F

This includes 6 city schools (Klamath Union High (location of Big Springs), Mazama High School, Roosevelt Elementary Ponderosa Jr. High ((largest downhole exchanger system with a 0.88 MWt capacity), Mills Elementary and Klamath Insitute)

Klamath County Maintenance Shop

Space Heating

Capacity 0.5 MWt Annual Energy Use: 1.1 GWh/yr CO₂ emissions saved: 880 tons/yr
Temperature 118°F

Klamath Falls Swimming Pools (4)

Resort/Spa

Capacity 0.3 MWt Annual Energy Use: 1.3 GWh/yr CO₂ emissions saved: 1,040 tons/yr
Temperature 180°F

This includes the 4 pools located in Klamath Falls (OIT pool, Ellen Redkey swimming pool, KU pool and YMCA pool). The Ella Redkey Municipal swimming pool uses a downhole heat exchanger.

YMCA

Space Heating

Capacity 0.4 MWt Annual Energy Use: 0.9 GWh/yr CO₂ emissions saved: 720 tons/yr
Temperature 147°F

The pool heating information is included in the Klamath Falls Swimming Pools numbers

YMCA website

<http://www.kfallsymca.org/default.asp>

Henley High School (Klamath County School)

Space Heating

Capacity 0.9 MWt
Temperature 127°F

Annual Energy Use: 1.9 GWh/yr

CO₂ emissions saved: 1,520 tons/yr

Klamath Falls Apartment Buildings (13)

Space Heating

Capacity 0.9 MWt
Temperature average 180°F

Annual Energy Use: 1.9 GWh/yr

CO₂ emissions saved: 3,360 tons/yr

Klamath Falls Churches (5)

Space Heating

Capacity 0.5 MWt
Temperature 109°F

Annual Energy Use: 1.1 GWh/yr

CO₂ emissions saved: 880 tons/yr

Klamath Hills, Klamath County

Gone Fishing

Aquaculture

Capacity 1.2 MWt
Temperature 210°F

Annual Energy Use: 8.2 GWh/yr

CO₂ emissions saved: 6,550 tons/yr

A small part of the operation is located on the Liskey Ranch .

Case Study

“Gone Fishing” Aquaculture Project, Klamath Falls, Oregon

<http://geoheat.oit.edu/bulletin/bull24-2/art3.pdf>

Geothermal Resources Council Bulletin article

<http://www.geothermal.org/articles/fish.pdf>

Liskey Ranch

Liskey Greenhouses, Greenhouse

Capacity 1.7 MWt
Temperature 199°F

Annual Energy Use: 4.5 GWh/yr

CO₂ emissions saved: 3,600 tons/yr

GreenFuels of Oregon, Industrial

Capacity N/A
Temperature 180°F

Annual Energy Use: N/A

CO₂ emissions saved: N/A

The two operations are located on the Liskey Ranch. The Biodiesel should be operational by this summer. The equipment is in place waiting on the feedstock.

Newspaper Article

Persistence & innovation: Liskey family found ways to profit from geothermal water

<http://www.capitalpress.info/main.asp?SectionID=67&SubSectionID=792&ArticleID=31132&TM=7157.174>

Bulletin Articles

New Greenhouses in Klamath Falls

<http://geoheat.oit.edu/bulletin/bull23-3/art3.pdf>

GreenFuels of Oregon: Geothermal Energy utilization in Biodiesel

<http://geoheat.oit.edu/bulletin/bull28-1/art3.pdf>

Klamath County

Langel Valley, Bonanza

Space Heating

Capacity 0.03MWt
Temperature 147 °F

Annual Energy Use: 0.03 GWh/yr

CO₂ emissions saved: 24 tons/yr

Olene Gap

Space Heating

Capacity 0.03 MWt Annual Energy Use: 0.03 GWh/yr CO₂ emissions saved: 24 tons/yr
Temperature 189°F

A home is heated from a thermal spring and nearby a 450 ft well could produce 300 gpm at 224 F. About half a dozen thermal springs exist in the area. (Sammel, 1980)

Lakeview

Hunter's Hot Springs Resort

Space Heating

Capacity 0.2 MWt Annual Energy Use: 0.5 GWh/yr CO₂ emissions saved: 400 tons/yr
Temperature 202°F

Resort/Spa

Capacity 0.3 MWt Annual Energy Use: 2.1 GWh/yr CO₂ emissions saved: 1680 tons/yr
Temperature 202°F

"Old Perpetual" is the name to Lakeview's famous Geyser, located at Hunter's Resort just North of Lakeview. This Geyser was created by the accidental drilling of a water well. The drilling tapped into the geothermal hot water table below the surface, and ever since a Geyser of boiling water explodes nearly every minute.

Hunter's Hot Springs Resort website

<http://www.huntersresort.com/>

Other website

<http://www.lakevieworegon.us/Tour/Tour9.html>

Warner Creek Correctional Facility

Space Heating

Capacity N/A Annual Energy Use: N/A CO₂ emissions saved: N/A
Temperature °F

Oregon Department of Corrections website

<http://www.oregon.gov/DOC/OPS/PRISON/wccf.shtml>

Lakeview Residences (9)

Space Heating

Capacity 0.1 MWt Annual Energy Use: 0.3 GWh/yr CO₂ emissions saved: 240 tons/yr
Temperature 190°F

Nine homes (Justus, 1979)

The Greenhouse

Greenhouse

Capacity 1.4 MWt Annual Energy Use: 3.6 GWh/yr CO₂ emissions saved: 2880 tons/yr
Temperature 220°F

PO Box 709, Lakeview, OR 97630 541-947-3923

Lakeview Swimming Pool

Reosrt/Spa

Capacity 0.2 MWt Annual Energy Use: 0.5 GWh/yr CO₂ emissions saved: 400 tons/yr
Temperature 180°F

A public swimming pool uses geothermal for pool, Domestic Hot Water and locker room heating

Ashland

Jackson Wellsprings

Space Heating

Capacity 0.2 MWt Annual Energy Use: 1.3 GWh/yr CO₂ emissions saved: 1040 tons/yr
Temperature 111°F

Greenhouse

Capacity 0.09MWt Annual Energy Use: 0.1 GWh/yr CO₂ emissions saved: 80 tons/yr
Temperature 111°F

Resort/Spa

Capacity 0.3 MWt
Temperature 111°F

Annual Energy Use: 2.1 GWh/yr

CO₂ emissions saved: 1680 tons/yr

Jackson Wellsprings, a 30 acre hot springs spa located 1.5 miles from the Oregon Shakespeare Festival in pastoral Ashland, Oregon specializes in mineral springs, swimming, hot water soaking and massage therapy. Eugene Jackson dedicated that the warm mineral springs arising from Jackson Hot Springs shall be utilized for the purposes of health and healing. In 1862 deeded water rights filed with Jackson County protected the springs for "sanitarium and natatorium purposes". Today, almost 80,000 gallons of warm water are collected each day and pass into the 45 x 90 foot swimming pool and private soaking tubs. One of WellSprings' strongest features, the mineral water is the cornerstone of the spa and hydrotherapy center. A warm water therapy pool measuring 14 x 18 feet is maintained at 97 degrees during daytime hours. Water temperatures are boosted during evening hours to 103. Our 100 x 30 foot propagation greenhouse and shade house greatly enhance WellSprings' abilities to introduce diversity to its botanical gardens and pharmacy, alike.

Jackson Wellsprings website

<http://jacksonwellsprings.com/>

Lithia Springs Resort

Space Heating and Resort/Spa

Capacity 0.2 MWt
Temperature 220°F

Annual Energy Use: 1.3 GWh/yr

CO₂ emissions saved: 1040 tons/yr

Lithia Springs Resort website

<http://www.ashlandinn.com/index.html>

Vale

Oregon Trail Mushrooms

Industrial

Capacity 1.5 MWt
Temperature 220°F

Annual Energy Use: 12.6 GWh/yr

CO₂ emissions saved: 10,070 tons/yr

Vale Residences(5), Space Heating

Capacity 0.09MWt
Temperature 185°F

Annual Energy Use: 0.2 GWh/yr

CO₂ emissions saved: 160 tons/yr

Ag Dryers, Agricultural Drying

Capacity: 0.9 MWt
Temperature: 200°F

Annual Energy Use: 1.9 GWh/yr

CO₂ Emissions saved: 1,520 tons/yr

Vale Swimming Pool Resort/Spa

Capacity 0.3 MWt
Temperature °F

Annual Energy Use: 2.1 GWh/yr

CO₂ emissions saved: 1,680 tons/yr

Case Study

Oregon Trail Mushrooms

<http://geoheat.oit.edu/bulletin/bull25-1/art5.pdf>

Vale Slaughter House

Space Heating

Capacity 0.09MWt
Temperature 150°F

Annual Energy Use: 0.2 GWh/yr

CO₂ emissions saved: 160 tons/yr

Case Study

Oregon Trail Mushrooms

<http://geoheat.oit.edu/bulletin/bull25-1/art5.pdf>

Summer Lake

Summer Lake Hot Springs

Space Heating

Capacity 0.3 MWt
Temperature 113°F

Annual Energy Use: 0.7 GWh/yr

CO₂ emissions saved: 560 tons/yr

Resort/Spa

Capacity 0.3 MWt Annual Energy Use: 2.1 GWh/yr CO₂ emissions saved: 1680 tons/yr
Temperature 113°F

Summer Lake Hot Springs is graced by four natural hot springs. The spring that serves as the source for the swimming pool produces approximately 25 gallons of water per minute, at a temperature of 113 degrees. The other springs generate water ranging from 106 to 118 degrees, and serve the various houses and facilities on the property, including the new geothermally heated cabins. Prior to the early settlers' arrival, the undeveloped springs were known as "Medicine Springs" to the native Americans. In 1843, explorer John Fremont (the man credited with naming Summer Lake, due to the area's banana belt climate) once commented on the water's healing properties, praising the mineral springs as the best he'd come across. Today, this same therapeutic natural mineral water continues to flow through the original 15 by 30 foot pool, maintaining a temperature of 103 degrees.

Summer Lake Hot springs website

<http://summerlakehotsprings.com/index.html>

Another website

<http://oregonhotsprings.immunenet.com/smmrlake.htm>

Summer Lake Aquaculture

Aquaculture

Capacity 1.2 MWt Annual Energy Use: 8.2 GWh/yr CO₂ emissions saved: 6,550 tons/yr
Temperature N/A

Contact Desert Springs – Lyle Negus – 541-943-3192

Crane

Crystal Crane Hot Springs

Resort/Spa

Capacity 0.3 MWt Annual Energy Use: 2.1 GWh/yr CO₂ emissions saved: 1,680 tons/yr
Temperature 185°F

Simple. Rustic. Clean. Crystal Crane Hot Springs offers you the relaxing pleasure of a hot spring, with amenities that allow you to fully and peacefully enjoy your soak.

Crystal Crane website

<http://www.cranehotsprings.com/>

GeoGardens Inc.

Greenhouse

Capacity N/A MWt Annual Energy Use: N/A GWh/yr CO₂ emissions saved: N/A tons/yr
Temperature °F

Jean Cain 59611 Hwy 78 Burns OR 97720

La Grande

Hot Lake Springs

Hot Lake Hotel, Space Heating and Resort/Spa

Capacity 0.3 MWt Annual Energy Use: 2.1 GWh/yr CO₂ emissions saved: 1,680 tons/yr
Temperature 208°F

The pool heating numbers are included in the space heating numbers. A thermal spring provides space heating to the Hot Lake Hotel and 1320 ft transmission line delivers heat to space heating, domestic hot water, hot tubs and a swimming pool at the RV park. (Rafferty, 1986). The springs flow at about 1,000,000 gallons of water a day. The average water temperature of the springs is 208 degrees.

Hot Lake Hotel website

<http://hotlakesprings.lbsites.com/index.htm>

Eagles Hot Lake RV, Space Heating and Resort/Spa

Capacity 0.3 MWt Annual Energy Use: 0.5 GWh/yr CO₂ emissions saved: 400 tons/yr
Temperature 186°F

Hot Lake has an interesting geological, pioneer, and medicinal history. The 2½ million gallons of hot (186°) water that flow out of the ground every day have always been a natural attraction for travelers in the Grand Ronde Valley. Seven Western Indian tribes used its "curative powers" and set it aside as a peace ground. The Hot Lake area was used for rest and healing of their sick and wounded, and as a summer rendezvous area. Hot Lake was first seen by white men on August 7, 1812. The

Wilson Price Hunt expedition was traveling from what is now Astoria, Oregon, to St. Louis, Missouri, and noticed the hot spring.

Eagles Hot Lake RV website
<http://www.eagleshotlakerv.com/>

Detroit

Breitenbush Hot Springs

Space Heating

Capacity 0.4 MWt Annual Energy Use: 1.1 GWh/yr CO₂ emissions saved: 880 tons/yr
Temperature 212°F

Resort/Spa

Capacity 0.3 MWt Annual Energy Use: 2.1 GWh/yr CO₂ emissions saved: 1680 tons/yr
Temperature 212°F

The abundant hot springs have long been a destination for those seeking healing, rejuvenation and community. Three Meadow Pools are lined with smooth rocks and overlook the river. The four tiled Spiral Tubs are aligned in the cardinal directions with increasing temperatures. They are adjoined by the cedar tub cold plunge. The Sauna is a whimsical cedar cabin resting atop the bubbling waters. The cabins are kept cozy year round with heat from the Earth's waters.

Breitenbush website
<http://breitenbush.com/>

Union County

Medical Hot Springs

Space Heating and Resort/Spa

Capacity 0.2 MWt Annual Energy Use: 0.3 GWh/yr CO₂ emissions saved: 240 tons/yr
Temperature 140°F

A pioneer resort that featured an Olympic-sized swimming pool and a large hotel which is now closed to the public. The hot springs emerge from the ground at 140°F, and then are piped 200 yards to the 50 ft by 150 ft swimming pool, where the water is cooled to around 104°F. (Touring Washington and Oregon Hot springs, 2002)

This remote hot springs resort hails from the historical era of major fashionable hot springs resorts, of which Oregon had several. After many years of closure, Medical Springs' saga is recently more hopeful. One of the original homesteading descendants has retired and returned to the family homestead at the hot springs with dreams of bringing back Medical Springs, perhaps as some type of bed and breakfast.

Other website
<http://www.oregonphotos.com/Medical%20Springs.html>

Cove

Cove Hot Spring

Greenhouse

Capacity 0.2 MWt Annual Energy Use: 0.4 GWh/yr CO₂ emissions saved: 320 tons/yr
Temperature 108°F

Other website
<http://www.coveoregon.org/covewelcome.shtml>

Cove Swimming Pool

Resort/Spa

Capacity 0.3 MWt Annual Energy Use: 2.1 GWh/yr CO₂ emissions saved: 1,680 tons/yr
Temperature °F

The springs are gathered in a well-designed, concrete pool, providing nearly perfect 86 degree water. The pool, measuring 60' x 65', is constantly refreshed by the flow of sweet mineral water at a rate of 110 gallons per minute.

Warm Springs Pool at Forest Cove
http://www.coveoregon.org/localattractions_pool.shtml

Haines

Radium Hot Springs

Space Heating and Resort/Spa

Capacity 0.2 MWt

Annual Energy Use: 1.1 GWh/yr

CO₂ emissions saved: 880 tons/yr

Temperature 136°F

Another of Oregon's early western health spa hot spring resorts, Radium has been closed to the public since 1986. Radium was originally called the Haines Hot Springs Sanitarium as dubbed by its builder, Dr. May. The structure was a 100 room, two story building that burned shortly after its completion in 1906. Rebuilt, it burnt down again 1915, and then the final original buildings succumbed to fire in 1926. Soon after, based on the success of the thermally heated pool in Cove, plans were executed to build a similar pool. This structure is still in place and can be see in the aerial photos below. The pool officially opened on July 4th, 1926. The pool ran in different capacities for 60 years, but has now been closed to the public for more than 20 years.

Other website

<http://oregonhotsprings.immunenet.com/radium.htm>

Newspaper article: Historic hot springs on the auction block Published: April 26, 2007

http://www.bakercityherald.com/news/story.cfm?story_no=4909

Newspaper article: Hot Springs not for sale Published: April 27, 2007

http://www.bakercityherald.com/news/story.cfm?story_no=4913

Clackamas County

Austin Hot Springs

Resort/Spa

Capacity 0.6 MWt

Annual Energy Use: 0.30 GWh/yr

CO₂ emissions saved: 240 tons/yr

Temperature 186°F

There is a large spring across the North Fork of the Clackamas River that is almost a flash point spring (a flash point spring comes out of the ground as steam). The springs on the road side of the river are located under the rocks on the bank. The water here is very hot and is mixed in pools with the river water. Be very careful at this spring as the water temperature may change quickly. Austin Hot Springs is private property and signs used to be posted warning of the near flash point (where the water comes out of the ground as steam at 210 degrees) water temperatures.

Other websites

<http://members.tripod.com/~rexs13/austin.htm>

<http://www.oregonraindance.com/playit/austin.htm>

Bagby Hot Springs

Resort/Spa

Capacity 0.3 MWt

Annual Energy Use: 2.1 GWh/yr

CO₂ emissions saved: 1,680 tons/yr

Temperature 136°F

At 2280 feet elevation, the hot springs is managed cooperatively by the Forest Service and a volunteer group, the Friends of Bagby. . The private tubs are 10 feet long by 2-3 feet wide cedar logs that have been hollowed out. The hot water comes out of two springs at about 136 degrees. The spring water is channeled by wooden flumes into numerous bath houses and private tubs When mixed with the cold water from nearby springs it is a very enjoyable soak. Bagby Hot Springs was "discovered" by Robert Bagby, a miner from Amity, Oregon, in 1881. The Native Americans used the springs for centuries before him. Legend has it that there were no weapons permitted in the area of the springs so that the people visiting the springs for healing could do so without conflict.

Other websites

<http://members.tripod.com/~rexs13/bagby.htm>

<http://oregonhotsprings.immunenet.com/bagby.htm>

Adams

Bar M Ranch

Resort/Spa

Capacity 0.3 MWt

Annual Energy Use: 2.1 GWh/yr

CO₂ emissions saved: 1,680 tons/yr

Temperature °F

The natural hot springs water, which flows right out of the mountain, fills our 60 x 40 foot / 18 x 12 meter swimming pool and maintains a temperature of 86°F year round. The hot tub (which had a facelift and now sports jets and a heat pump) can get up to 105°F. For years people have come to Bingham Springs to soak in the water for the medicinal properties it is believed to contain. People enjoy the peace and tranquility of a late evening dip under the stars or soak in the hot tub filled with mineral water from the spring.

Bar M Ranch website

<http://www.barmranch.com/index.php?page=1>

McKenzie Bridge

Belknap Hot Springs

Resort/Spa

Capacity 0.3 MWt

Annual Energy Use: 1.6 GWh/yr

CO₂ emissions saved: 1,280 tons/yr

Temperature 160°F

A well know commercial resort on the banks of the McKenzie River.

Belknap website

<http://www.belknaphotsprings.com/>

Prairie City

Blue Mountain Hot Spring

Resort/Spa

Capacity 0.3 MWt

Annual Energy Use: 2.1 GWh/yr

CO₂ emissions saved: 1,680 tons/yr

Temperature 120°F

A hot spring with a vibrant past, Blue Mountain has had frequent visitors over the years and remains a settled destination at present. At its source the springs are 120° F but as they flow into the swimming pool they cool to about a 100 degree average. Warmer spots are closer to the piped in source, while the pool gets cooler towards the far end. The springs have been frequented as far as history is recorded for the area. The first documented settlement of the springs were by a furniture maker and his wife in the 1860s. As the decades past the springs became known as a destination for viewing the mystery of geothermal activity, those seeking wellness from the mineral rich water, drinking, swimming, and bathing. At one time under private ownership, today the hot springs are a scenic destination open to outside guests.

Other website

<http://oregonhotsprings.immunenet.com/bluemtn.htm>

Canyon City

J Bar L Guest Ranch

Resort/Spa

Capacity 0.3 MWt

Annual Energy Use: 2.1 GWh/yr

CO₂ emissions saved: 1,680 tons/yr

Temperature °F

Warm Springs

Kah-nee-ta

Resort/Spa

Capacity 2.0 MWt

Annual Energy Use: 8.8 GWh/yr

CO₂ emissions saved: 7,030 tons/yr

Temperature 128°F

Case Study

Kah-Nee-Ta Swimming Pool, Warm Springs, Oregon

<http://geoheat.oit.edu/bulletin/bull25-1/art1.pdf>

Kah-Nee-Ta website

<http://www.kahneeta.com/>

Ukiah

Lehman Hot Springs

Resort/Spa

Capacity 0.3 MWt
Temperature 167°F

Annual Energy Use: 2.1 GWh/yr

CO₂ emissions saved: 1,680 tons/yr

Located west of La Grande, Lehman Hot Springs is one of the largest hot springs in the Northwest. The springs were formerly a gathering place for the Nez Perce Indians. The 9,000 foot square swimming pool has temperatures ranging from 88 to 106 degrees F. Relax in the soothing hot pools, or take an invigorating swim in the large pool.

Lehman Hot Springs website

<http://www.lehmanhotsprings.com/>

Ritter

Ritter Hot Springs

Resort/Spa

Capacity 0.3 MWt
Temperature 106°F

Annual Energy Use: 2.1 GWh/yr

CO₂ emissions saved: 1,680 tons/yr

A historic overnight stop on the old stagecoach road between Pendleton and John Day. The hot springs emerge from the ground at 106°F. The hot water is piped across the Middle Fork of the John Day River to the swimming pool, which averages 85°F.

The total CO₂ emissions savings for the State of Oregon totals to approximately 151,198 tons/yr.

Reference for CO₂ are Goddard and Goddard, GRC Transactions, Vol. 14, Part I (1990), p. 649.

Oregon Geothermal Resources

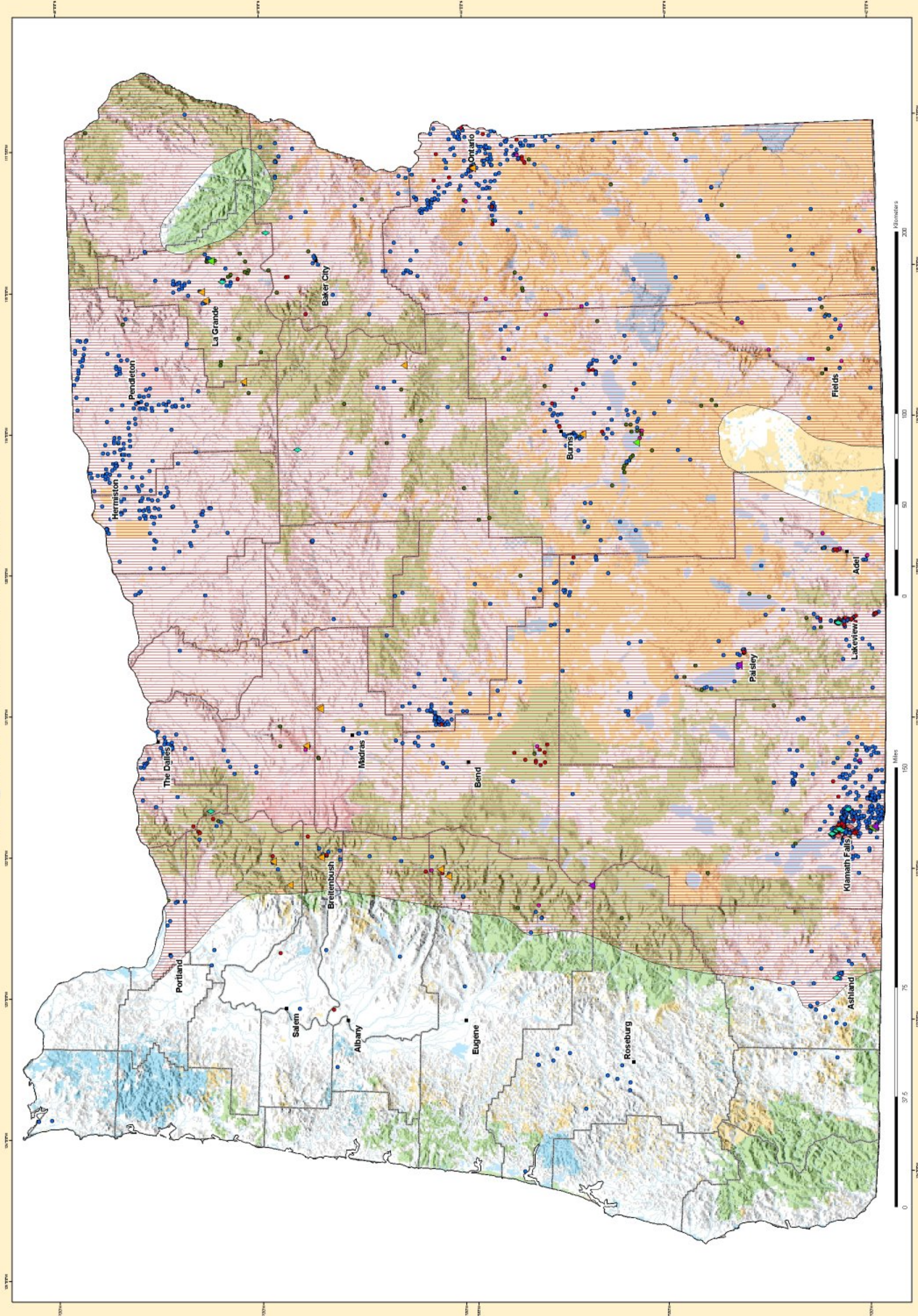

Legend

- Cities/Towns
- County Boundaries
- Rivers/Streams
- Lakes/Reservoirs
- ▲ Greenhouse
- ▲ Space Heating
- ▲ District Heating
- ▲ Aquaculture
- ▲ Spas/Resorts/Recreation Sites
- ▲ Regions of Known or Potential Geothermal Resources

Geothermal Categories

- Wells > 50 Degrees C
- Springs > 50 Degrees C
- Wells > 20 and <= 50 Degrees C
- Springs > 20 and <= 50 Degrees C

Ownership

- Private Lands
- Bureau of Land Management and Other Federal Lands
- State Lands
- Native American Lands
- U.S. Forest Service Lands

Map prepared by Patrick Laney and Julie Brzecz at the Idaho National Engineering and Environmental Laboratory
 For
 The U.S. Department of Energy Office of Energy Efficiency and Renewable Energy Geothermal Technologies Program

Geothermal Data Provided by:

1. Geo-Heat Center State Geothermal Database, [Compact Disk], February 2002
2. National Geophysical Data Center, National Oceanic and Atmospheric Administration, 1982, Geothermal Resources of Oregon. Prepared for the Division of Geothermal Energy, United States Department of Energy, Map 1:500,000

Oregon Geothermal Resources
 Publication No. - INEEL/MIS-2002-1621 Rev. 1
 November 2003

Map Projection Information:
 Projection: Lambert Conformal Conic
 Units: Meters
 Central Meridian: -121.00
 Standard Parallel 1: 33.00
 Standard Parallel 2: 45.00
 Datum: North American 1927



GEO-HEAT CENTER

Oregon Institute of Technology Klamath Falls, Oregon 97601 541/885-1750 FAX 541/885-1754

John W. Lund, Director
Tonya "Toni" Boyd
Andrew Chiasson

Possible Oregon Geothermal Power Plant Sites

Compiled by Toni Boyd
December 2006

Assumptions

The smallest United Technologies Company power plant units are 200 kWe in size. The smallest ORMAT binary systems are 1 MWe in size. These numbers will be used to make recommendations.

Some other assumptions used are (From a spreadsheet by Dan Hand, Chevron):

- Cost of Electricity \$0.06 / kWh
- Rejection Temperature 80°F (27°C)
- Turbine Isentropic Efficiency – 85 %
- Temperature Differential – 20°F (11°C)
- Operational hours (95% on line) – 8322
- Power Plant cost per kW - \$4,000
- Drilling cost - \$100/ft (low side) (\$300/m)
- Oregon Department of Energy – ODOE
- Oregon Energy Tax Credit – assumed 25% of cost

The numbers used for the assumptions of power plant job full time positions, person* yrs construction and manufacturing jobs and the 30 year economic output were taken from the following publication "A Handbook on the Externalities, Employment, and Economics of Geothermal Energy" by Alyssa Kagel, GEA (October 2006). The employment numbers in this report are for much larger plants (50 MWe) and should probably be only half that stated below.

Other publications used were "Assessment of Geothermal Resources of the United States – 1978, Geological Survey Circular 790" and Western Governor's Association Clean and Diversified Energy Initiative – Geothermal Task Force Report, Jan 2006.

Below are only recommendations and assumptions for there are a lot of variables that could change the amount of power that could be produced. For example the temperature of the cooling water and the amount of flow available would affect the amount of power that could be produced at any of these sites. The smaller the temperature difference between the geothermal water and the cooling water the less power the system can produce.

Part of the information below is summarized in the Spreadsheet power-summary.xls

Recommendations

Places listed in Table 6 of Circ 790 (90 – 150°C)

Mt Hood Area

This area includes Government Camp (estimated population of 735) which has three wells located within 8 km (5 miles) of the community. According to the Circ 790 it has a potential of 21.7 MWe. The highest temperature is 121°C (250°F) and the lowest is 80°C (176°F). The deepest well at 1837 m (6026 ft) is also the hottest. The other two wells are about 1220 m (4000 ft). It looks like the wells listed were exploration wells and I am not sure if they are usable. There are no flows listed either.

For the assumption of possible power generation if we assume the lower temperature well (80°C)(176°F) is usable and has a flow of 2,271 L/min (600 gpm) it could produce about 226 kWe. The cost would be approximately \$903,000 if no wells have to be drilled. With a possible \$226,000 possible incentive from ODOE for the BETC the net investment would be approximately \$677,000. If they have to drill a well (assumed depth of 1220 m (4000 ft)) the cost would be \$1,300,000, \$326,000 and \$977,000 respectively.

This would produce one power plant job full time position and four person* yrs construction and manufacturing jobs. The 30 year economic output would be approximately \$3.4 million.

The water after being used in the power plant will have a temperature of 69°C (157°F) which could hot enough for direct uses like snow melting, space heating, greenhouse aquaculture and other uses.

Carey (Austin) Hot Springs

There are two wells and one spring in this area, which is located in the Mt. Hood National Forest. There is no communities located close for the use of the geothermal water as a cascaded use after going through the power plant, which will make the cost effectiveness of the power plant null. The ranges of temperature are 82 – 86°C (180 – 187°F) with depths of 460 and 293 meters (140 and 89 m). These wells look like they were exploration or gradient holes and I am not sure if they are usable. The spring has a listed flow of 1000 L/min (264 gpm) which would generate about 100 kWe. As mentioned in the beginning the smallest plant available is 200 kWe.

If we assume using a well with a temperature of 84°C (183°F) and a flow 1893 L/min (500 gpm) it could produce about 200 kWe. The cost would be approximately \$799,000 if no wells have to be drilled. With a possible \$200,000 incentive from ODOE for the BETC the net investment would be approximately \$600,000. If they have to drill a well (assumed depth of 375 m (1230 ft)) the cost would be \$922,000, \$230,000 and \$692,000 respectively.

This would produce one power plant job full time position and three person* yrs construction and manufacturing jobs. The 30 year economic output would be approximately \$3.0 million.

Last I heard Austin Hot Springs was for sale.

Breitenbush Hot Springs

There are five wells and one spring listed. There is a wide range of temperatures from 78 to 141°C (172 to 286°F) and the depths vary from 150 to 2457 meters (46 to 749 ft). The two hottest wells are also the deepest and shallowest. They are located within the Breitenbush area and five miles from Idana with a population of 289.

The information below was taken from the Breitenbush website

<http://www.breitenbush.com>

Breitenbush Retreat and Conference Center is a worker-owned cooperative with workers and their families living as an intentional community and eco-village on 154 acres of wildlife sanctuary in the Willamette National Forest.

After looking over the Breitenbush website especially their sustainability page and I doubt they would be interested in geothermal power. I would assume the Idana community would be interested though.

If we can assume Idana could use the spring which has a temperature of 92°C (198°F) and a flow of 3400 L/min (898 gpm) it could produce 399 kWe. The cost would be \$1,595,000 with a possible incentive from ODOE for the BETC of \$399,000 for a net investment of \$1,196,000. If they have to drill a well (assumed depth of 1640 ft (500 m)) the cost would increase to \$1,759,000 with a \$440,000 possible tax credit and a net investment of \$1,319,000.

This would produce two power plant job full time position and six person* yrs construction and manufacturing jobs. The 30 year economic output would be approximately \$6.0 million.

Kahneetah Hot springs

There is one spring at a temperature of 83°C (181°F); everything also is below 70°C (158°F). I have heard the Warm Springs Indians are looking into the feasibility of exploration for geothermal power generation among other renewables, but it looks like the geothermal is later into the future. Dave McClain would be the person to contact for information on the project. With the existing information I would not consider Kahneetah as a possible site at this time, since there is no evidence of

hotter geothermal.

Belknap Hot Springs

There is a lodge and other facilities at the Belknap Hot Springs would could benefit from the power and the community of McKenzie Bridge (300 Pop.) is located within 8 km (5 miles) of the springs. There are two springs listed in the area but no wells with a temperature of over 74°C (165°F). The temperatures of the springs are 89°C (192°F) and 81°C (178°F). The flow 284 L/min (75 gpm) reported for the higher temperature spring would only produce 32 MWe of power. If the flow were 1893 L/min (500 gpm) it could produce 214 kWe.

If they drill a well (305 m (1,000 ft)) and can obtain a higher flow of 1893 L/min (500 gpm) and a temperature of 89°C (192°F) then they can produce 200 kWe. The cost would be \$957,000 with a \$239,000 possible tax credit and a net investment of \$718,000.

This would produce one power plant job full time position and three person* yrs construction and manufacturing jobs. The 30 year economic output would be approximately \$3.2 million.

McCreadie Hot Springs

The springs flank both sides of Salt Creek and located on Forest Service land. The temperature is very marginal and so is the flow.

Umpqua Hot Springs

There is no resource above 50°C (122°F) so I would not consider this one at this time. Plus located on Forest Service land could be an impediment.

Klamath Hills area

There are eight wells located in the area with temperatures above 70°C (158°F) and with shallow depths. This is an agricultural area where the Klamath Economic Development has been looking into setting up an industrial park. There are already greenhouses and aquaculture operations in the area. This would be a good area to look into. I have also heard there is a company looking into a biodiesel plant in the area using geothermal. From what I heard it is not easy finding a cold water well in the area.

If the well KL-320 (90°C, 127 meters (194°F, 417 ft)) could be used, which has a flow listed of 1700 L/min (450 gpm); it could produce about 196 kWe at this time. No other wells in the area has a flow listed in the database. The cost would be \$782,000 with a possible tax credit of \$196,000 and a net investment of \$587,000. This is assuming no drilling.

This would produce one power plant job full time position and three person* yrs construction and manufacturing jobs. The 30 year economic output would be approximately \$2.9 million.

Klamath Falls area

OIT is looking into two different types of plants, one (low-temp) to produce 200 kWe with the existing wells 89°C (192°F) and still have capacity to heat the campus and another to produce one MWe with a proposed 1,524 – 1,829 m (5,000 – 6,000 ft) well to encounter the 149°C (300°F) water which is believed to be at depth. The low temperature power plant would use the existing wells that are used for space heating the campus at this time. The power plant will take 8°C (15°F) from the water before it is used to heat the campus with the lower temperature of 81°C (177°F). It is possible to have this power plant in operation by the end of 2007. The cost of this power plant is approximately \$800,000. The high temperature plant would involve drilling a deep well (1,524 – 1,829 m (5,000 – 6,000 ft)). The cost to drill the well is \$2.2 million and the total cost for the power plant including drilling will be approximately \$5.0 million. This will also provide the campus with more geothermal water for expansion, plus the opportunity to provide other businesses in the area with geothermal water. They are looking into an RFP for the drilling, but contracts for drilling could take years.

The low-temp power plant would produce one power plant job full time position and three person* yrs construction and manufacturing jobs. The 30 year economic output would be approximately \$3.2 million. The high-temp power plant would produce five power plant job full time position and 18 person* yrs construction and manufacturing jobs. The 30 year economic output would be approximately \$16.5 million.

Klamath Falls is also looking at power production using their existing district heating system. They were contacted by Dan Hand of Chevron. With their flow (3,028 L/min (800 gpm)) and temperature (100°C (212°F)) they can produce 413 kWe on

their existing system and still have capacity for the district heating with not much expansion possible in the future. The cost would be \$1,652,000 with a possible tax credit of \$413,000 and a net investment of \$1,239,000. If they drill a 305 m (1,000 ft) well to supplement the existing district heating system and power plant the cost would increase to \$1,752,000 with a possible tax credit of \$438,000 and a net investment of \$1,314,000.

This would produce two power plant job full time position and seven person* yrs construction and manufacturing jobs. The 30 year economic output would be approximately \$6.2 million.

Most of the other high temperature wells are located in a residential area where it would be hard to set up a power plant. The wells located in the commercial district of the town are not sufficient to produce power.

Summer Lake Hot Springs

This area is located within proximately of Paisley there are five wells over 70°C (158°F) with depths ranging from 126 m (413 ft) to 300 m (985 ft). All the wells listed have the same name associated with them and I would assume they are located on a ranch in the area since the latitudes and longitudes of the wells are close. There are no flows listed but if we assume a flow rate of 1500 L/min (396 gpm) for the high temperature well of 111°C (232°F) it can produce 200 kWe. The cost would be \$863,000 with a possible tax credit of \$216,000 and a net investment of \$647,000.

This would produce one power plant job full time position and three person* yrs construction and manufacturing jobs. The 30 year economic output would be approximately \$3.2 million.

Lakeview area

This area has 25 wells and four springs listed with a temperature of 70°C (158°F) and above. The highest temperature well is also the deepest. I would assume this was an exploration well. The depth is 1658 m (5,440 ft) with a 116°C (241°F) temperature. Since there is no flow listed for this well I did not use this one in my assumptions. There is a 101°C (214°F) well with a flow of 3750 L/min (990 gpm) and a depth of 209 m (686 ft) and a spring with a temperature of 96°C (205°F) and 2000 L/min (528 gpm) which I will use for assumptions. At this time I am not sure if the well is located within the city limits, the spring is located at Hunter Hot Springs.

The 101°C (214°F) well using all of the flow could produce 488 kWe. The cost would be \$1,951,000 with a possible tax credit of \$488,000 and a net investment of \$1,463,000.

This would produce two power plant job full time position and eight person* yrs construction and manufacturing jobs. The 30 year economic output would be approximately \$7.3 million.

The spring located at Hunter Hot Springs could produce 246 kWe. I would assume the owner might be interested in the power generation as long as he is able to still use it for his other applications like space heating and pool heating. Not sure if he has the capacity to do both. The cost would be \$983,000 with a possible tax credit of \$246,000 for a net investment of \$738,000.

This would produce one power plant job full time position and four person* yrs construction and manufacturing jobs. The 30 year economic output would be approximately \$3.7 million.

Fisher and Weberg Hot Springs

There are no wells and springs listed over 70°C therefore I would not suggest either site at this time.

Harney Lake Area

The temperatures of the wells in this area are just below the temperature of the Chena Hot Springs well and I would not recommend this site at this time.

Crane Hot springs

This area contains a resort and down the road to the west there is a greenhouse operation. The temperatures are at 78° and 82°C (162° and 180°F) and the depth of the well is 76 m (249 ft). Using the following 82°C and 700 L/min (185 gpm) of flow it can only produce about 72 kWe and as I mentioned earlier the smallest available plant is 200 kWe plant. The owners of Crystal Hot Springs might be interested is a geothermal plant. If a well is drilled (305 m (1,000 ft)) in the area of Crystal Crane Hot Springs and they could encounter the same temperature and a flow of 2,082 L/min (550 gpm) they could produce 214 kWe. The cost would be \$857,000 with a possible tax credit incentive of \$214,000 for a net investment of \$643,000.

This would produce one power plant job full time position and four person* yrs construction and manufacturing jobs. The 30 year economic output would be approximately \$3.7 million.

Riverside Area

McDermitt area

Medical Hot Springs

The areas above have no resources that are listed above 70°C (158°F) and should not be considered at this time.

Little Valley area

There is one spring listed at 70°C (158°C) with a flow of 550 L/min (145 gpm) which is cooler than the well at Chena Hot Springs. If they could drill and obtain a well that can produce a temperature of 74°C (165°F) and a flow of 2,270 L/min (600 gpm) then they would be able to produce 200 kWe. The cost for the project would be \$814,000 which does not include drilling a well. I have no information to venture a guess on how deep the well would have to be.

Places not listed in Circ 790 but have high temperature wells and springs

Olene Gap

This is usually listed under Klamath Falls area which is about three miles from Klamath Falls. There are two wells and springs in the area. The temperatures range from 71° to 87°C (160° to 189°F) and the deepest well is 166 m (545 ft). One spring has a listed flow of 200 L/min (53 gpm). If we knew the flows of the wells we could come up with some good assumptions.

If we assumed the 87°C (189°F) well had a flow of 2010 L/min (531 gpm) it could produce about 220 kWe. The cost of the project would be about \$881,000 with a possible tax credit of \$220,000 and a net investment of \$661,000.

This would produce one power plant job full time position and four person* yrs construction and manufacturing jobs. The 30 year economic output would be approximately \$3.3 million.

Klamath County

There are two wells located in the Langel Valley area. The temperatures of the wells are 94° and 74°C (201°F and 165°F), but there is no flow listed for either one. This is in an area where the farmers will have their electrical pumping rates increased. This might be a good opportunity for the farmers to help with those costs. If we can assume the 94°C (201°F) well has a flow of at least 1700 L/min (4490 gpm) it could generate 205 kWe. The cost of the plant is about \$820,000 with a possible tax credit of \$205,000 and a net investment of \$615,000. This might be a cost that the community would be willing to share since in this area is where the pumping costs for irrigation will be increasing. I am sure this will not cover all the electricity needs for the area and the economics should be looked at to see if it would be beneficial to the farmers.

This would produce one power plant job full time position and three person* yrs construction and manufacturing jobs. The 30 year economic output would be approximately \$3.1 million.

New Pine Creek

There are four wells located in the area with a range of temperatures of 70° to 89°C (158° to 192°F). Looks like the wells are located on a ranch in the area since they are listed with the same name and the longitudes and latitudes are close. The 77°C (171°F) well has a flow of 15000 L/min (3,963 gpm) and will be used this for the assumption. This well could probably produce 1.4 MWe if they are able to find the right temperature of cooling water (probably around 7°C (45°F)) to make it efficient. The cost of the project would be \$5,607,000 with a possible tax credit of \$1,412,000 for a net investment of \$4,235,000.

This would produce six power plant job full time position and 23 person* yrs construction and manufacturing jobs. The 30 year economic output would be approximately \$21.2 million.

Ontario

There is one well in this area with a temperature over 74°C (165°F). This well 168°C (334°F) was drilled on the Ore-Ida property in hopes of using it for their french frying operation. The well was drilled to a depth of 3064 m (10,053 ft), but they encountered little or no flow. I am not sure if this well has been abandoned, but it might be possible in the future to use this as an enhanced geothermal system. If we can assume a flow of 984 L/min (260 gpm) for the well it can produce 207 kWe. The cost of the project would be \$829,000 with a possible tax credit of \$207,000 for a net investment of \$622,000. The water

after going through the power plant could probably then be used in the Ore-Ida plant. Even if they take out 56°C (100°F) out of the water it could still have a temperature of 106°C (224°F) which can be used in an industrial process.

This would produce one power plant job full time position and three person* yrs construction and manufacturing jobs. The 30 year economic output would be approximately \$3.1 million.

Nyssa

There is one well located in the area with a temperature of 84°C (183°F) with depth of 478 m (1568 ft), but no flow listed. This was an exploration well. If we assume the well has a flow of 2082 L/min (550 gpm) then it can produce 220 kWe. The cost would be \$879,000 with a possible \$220,000 tax credit and a net investment of \$659,000.

This would produce one power plant job full time position and four person* yrs construction and manufacturing jobs. The 30 year economic output would be approximately \$3.3 million.

Adrain

This area has two wells and spring listed in the area with temperatures ranging from 71° to 79°C (160° to 174°F). The depths of the wells are listed at 8 and 18 m (26 and 59 ft), but again no flows are listed. The spring has the highest temperature and if we assume a flow of 2082 L/min (550 gpm) it could produce 203 kWe. The cost of the project would be \$813,000 with a possible incentive of \$203,000 and a net investment of \$610,000. This looks like there might be some hotter temperatures at depth, but I have not heard much mention of this area. This area might be worth looking into.

This would produce one power plant job full time position and three person* yrs construction and manufacturing jobs. The 30 year economic output would be approximately \$3.0 million.

Marion County

This well is located in Marion County at 44.852 and 121.832. This could have been an exploration well, but can not be sure. It has a temperature of 87°C (189°F) with a depth of 1465 m (4,905 ft). If we assume the well has a flow of 1893 L/min (500 gpm) it can produce 208 kWe. The cost of the project would be approximately \$831,000 with a possible tax credit of \$208,000 and a net investment of \$623,000.

This would produce one power plant job full time position and three person* yrs construction and manufacturing jobs. The 30 year economic output would be approximately \$3.1 million.

Union

This area has two wells and two springs in the area. One of them is listed as Hot Lake Springs. It has a temperature listed at 85°C (185°F) and a flow of 5,700 L/min (1,506 gpm). This could probably produce 609 kWe. The cost of the project would be approximately \$2,435,000 with a possible tax credit of \$609,000 and a net investment of \$1,827,000. I am not sure if the resource is being used at this time, but it will still have quite a bit of beneficial heat after going through the power plant to be used for other applications of direct use.

This would produce three power plant job full time position and 10 person* yrs construction and manufacturing jobs. The 30 year economic output would be approximately \$9.1 million.

Table 5 from Circ 790 (above 150°C (302°F))

Newberry Caldera

The area is currently being explored and development for power generation. This project is being developed on federal leases. Since this is being actively explored I did not include this in the assumptions.

The information below was taken from Davenport Power's website

Davenport Power, LLC is the Project Operator and a co-owner of this geothermal field. The company controls 50% of Northwest Geothermal Company (NGC), a joint venture formed to develop the Newberry project on a 14,000 acre lease position.

The Newberry geothermal leases have been extensively drilled and explored. The field is potentially large, based on hot temperature gradient holes and a superheated steam well, with hundreds of megawatts of geothermal power potential. Newberry Volcano is considered one of the premier geothermal fields in the world.

Davenport Power on behalf of the Northwest Geothermal Company signed a 20-year power sales agreement with Pacific Gas & Electric Company, a major west coast utility, in July 2006. The agreement involves selling between 60 and 120 MWe of electricity from a proposed geothermal power project on the western side of the Newberry Volcano in central Oregon. Drilling preparation and environmental work will begin in 2006 and the first 30 MWe of the project is scheduled to achieve operating status in late 2009. The second 30 MWe is scheduled to begin operating in 2010 and provided that expected resource and transmission service are available, the remaining 60 MWe of the project is scheduled for 2011.

The Western Governor's Geothermal Task Report says that Newberry has a potential of having 240 MWe online by 2010 with a near market cost of \$0.08 / kWh.

If Davenport Power can get the 120 MWe power plant operation it could produce 510 power plant job full time position and 1920 person* yrs construction and manufacturing jobs. The 30 year economic output would be approximately \$1.8 billion.

Crump Hot Springs

This area is currently being explored for power generation. This project is being developed on private leases. Since this is being actively explored I did not include this in the assumptions.

The information below was taken from Nevada Geothermal Power's website

May 2006, an independent review by GeothermEx, Inc. of Richmond, California provide a preliminary estimate of capacity at Crump Geyser, a minimum of 40 MWe and most likely 60 MWe. A corporate review of the exploration results to date and the positive analysis by GeothermEx, Inc., NGP intends to advance the Crump Geyser project through reservoir drilling, testing and confirmation and project feasibility studies.

They are looking into placing 40 MWe online by 2008.

The Western Governor's Geothermal Task Report says that Crump Geyser has a potential of having 20 MW online by 2010 with a near market cost of \$0.08 / kWh.

If Nevada Geothermal Power can get the 40 MWe power plant operation it could produce 170 power plant job full time position and 640 person* yrs construction and manufacturing jobs. The 30 year economic output would be approximately \$599 million.

Mickey's Hot Springs

This area only has some springs with temperatures listed at 73°C (163°F). Listed as having a potential in Circ 790 (160 MWe) and in the Western Governors Geothermal Task Report (Near Term (25 MWe)), but with out extensive exploration to look into the resource I would not recommend this site at this time.

Alvord Hot Springs

This area is listing in Circ 790 but not as a potential site in the Western Governors Geothermal Task Report. One reason it was not considered is due to the chub fish located in the lake. It is considered an endangered species I think and there has been controversy over it that if they develop a power plant in the area it will affect the lake where the fish is located. There is one spring located in the area which I assume empties into the lake with a temperature of 78°C (172°F) and a flow of 1875 L/min (495 gpm). This spring could produce 180 kWe. The cost of the project would be approximately \$719,000 with a possible tax credit of \$180,000 and a net investment of \$539,000.

This would produce three power plant job full time position and 10 person* yrs construction and manufacturing jobs. The 30 year economic output would be approximately \$9.1 million.

Hot (Borax) Lake Area

This area only has a couple of springs listed with temperatures of 97° and 91°C (207°F and 196°F). The flow for each is listed as 10 L/min (2.6 gpm). Circ 790 lists this as having a potential of 91 MWe, and the Western Governor's Task Report has included this with the Lakeview area and both have a potential of 20 MWe. Without extensive exploration to look at the resource I would not recommend this site at this time.

Trout Creek Area

This area does not have a resource with a temperature over 70°C (158°F). Both the Circ 790 (24 MWe) and Western

Governor's Task Report (10 MWe) this area has a potential for power generation. Without extensive exploration to look at the resource I would not recommend this site at this time.

Neal Hot Springs

This area has been acquired by US Geothermal Inc. The company is currently developing a power plant project at Raft River in Idaho. Neal Hot Springs (8.5 square mile property) was acquired from a private party. Since this is being actively explored I did not include this in the assumptions.

The information below was taken from their website.

“We are pleased to have acquired this important geothermal resource, and we're working to advance the project to a development decision and have targeted an initial production potential of 25-30 MWe,” said David Kunz, U.S. Geothermal CEO, who emphasized that the Oregon site is close to transmission lines and a “great location” to serve Idaho Power's growing utility base as well as the broader Pacific Northwest energy market.

If US Geothermal Power can get the 25 MW power plant operation it could produce 106 power plant job full time position and 400 person* yrs construction and manufacturing jobs. The 30 year economic output would be approximately \$375 million.

Vale Hot Springs

This area has 30 wells and one spring which are located in town. The geothermal water is used for several direct use applications like refrigeration for mushroom growing, dry of corn and space heating. The highest temperature listed in the database is 115°C (239°F). The deepest well is 265 m (869 ft). The database does not include the exploration well that was drilled south of town. This well encountered a high temperature but encounter little or no flow. The wells located in town have encountered some water level drops in recent years. This would have to be taken into consideration if a power plant was to be developed in this area.

If we use the 115°C (239°F) well (MA-104) which has a flow of 1325 L/min (350 gpm) listed and the well (MA-105) with a temperature of 108°C (226°F) and a flow of 1514 L/min (400 gpm) for assumptions of potential power. The MA-104 well could produce 198 kWe and the cost of the project would be approximately \$794,000 with a possible tax credit of \$198,000 for a net investment of \$596,000. The MA-105 well could produce 212 kWe and the cost for the project would be \$849,000 with a possible tax credit of \$212,000 and a net investment of \$637,000.

The MA-104 well would produce one power plant job full time position and three person* yrs construction and manufacturing jobs. The 30 year economic output would be approximately \$2.9 million. The MA-105 well would produce one power plant job full time position and three person* yrs construction and manufacturing jobs. The 30 year economic output would be approximately \$3.2 million.

Oregon Communities with Geothermal Resource Development Potential

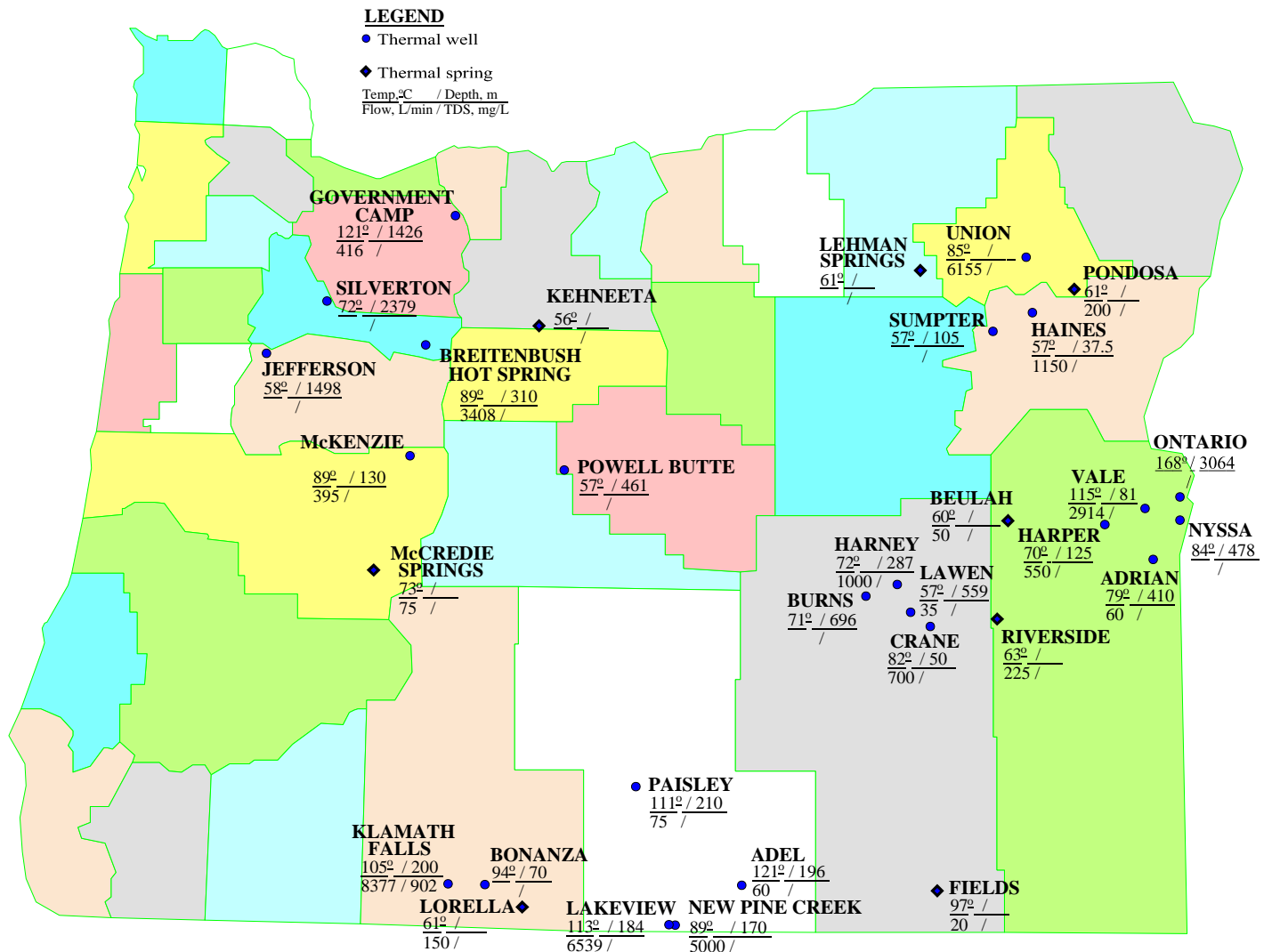

The cities and towns of Oregon shown on this map are located within 8 km (5 miles) of a known geothermal resource that has a temperature greater than 50°C (122°F)



GEO-HEAT CENTER

Oregon Institute of Technology Klamath Falls, Oregon 97601 541/885-1750 FAX 541/885-1754

John W. Lund, Director
Tonya "Toni" Boyd

Oregon Collocated Communities

Compiled by Toni Boyd
January 2008

A 1994 Oregon Department of Geology and Mineral Industries (DOGAMI) report entitled "Low-Temperature Geothermal Database for Oregon" by G. Black compiled a database of thermal wells and springs. These thermal wells and springs may represent more than 200 resources areas. The study concluded that the entire state east of the Cascade Range, except for the crest of the Wallowa Mountains, was favorable for the discovery at shallow depth (<3000 ft (<1000 m)) for thermal water sufficient temperature for direct-use applications.

The above mentioned database was further searched and compiled to include only those wells and springs with a temperature of 122°F (50°C) and above and located within 5 miles (8 km) of a community. The purpose of this compilation was to identify and encourage those communities to develop their geothermal resources. Historically, most of the communities that were identified have experienced some development of their geothermal resources. However, depending on the characteristics of the resource, the potential exists for increased geothermal development for applications such as space- and district heating industrial, greenhouse and aquaculture operations, resort/spa facilities and possible electric power generation in some areas.

There were 32 communities identified in Oregon and with a temperature at or above of 122°F (50°C). The communities are listed below by county and the information included for each community is temperature, depth, flow, number of wells and/or springs and what potential applications could be utilized at the given temperature.

Baker County

Haines

Temp 134°F

Depth 125 ft

Flow listed at 304 gpm

2 wells one spring

With this temperature there is a possibility of greenhouse and aquaculture operation, resort/spa facility and maybe space heating.

Sumpter / Bourne

Temp 134°F

Depth 345 ft

No flow listed

1 well

With this temperature there is a possibility of greenhouse and aquaculture operation, resort/spa facility and maybe space heating.

Clackamas County

Government Camp

Temp 250°F

Depth 4678 ft

Flow 110 gpm

3 wells

These were originally exploration wells and not sure if they are usable. Have to go deep for the temperature. The city is at the feasibility of developing a district heating system. Other possibilities are industrial, space heating, greenhouses and aquaculture operations and resort/spa facilities. There are two hot springs located in Clackamas which are Austin (186 F) and Bagby Hot Springs (136 F). We have been contacted by somebody interested in developing the Austin hot springs, but have not heard from them lately.

Crook County

Powell Butte

Temp 135°F

Depth 1512 ft

No flow listed

1 well

I think this was also another exploration well. With this temperature there is a possibility of greenhouse and aquaculture operation, resort/spa facility and maybe space heating. There are no developments around this area.

Harney County

Burns

Temp 160°F

Depth 2283 ft

No flow listed

2 wells

With this temperature there is a possibility of greenhouse and aquaculture operation, resort/spa facility and maybe space heating. According to database there are only two wells listed above 122°F. We do know there is a well located at the RV manufacturer place in Burns which uses the geothermal. I do not know of any other operations at this time in Burns.

Crane

Temp 180°F

Depth 164 ft

Flow 185 gpm

2 well and 1 spring

With this temperature there is a possibility of greenhouse and aquaculture operation, resort/spa facility and maybe space heating, but would be marginal for industrial applications. According to the database there are only 2 wells and one spring, I know of several others in the area at the greenhouse in Crane. I have also heard that a lot of the irrigation wells in the area are also warm. There is a greenhouse operation and a hot springs resort located within 2 miles of each other

Fields

Temp 206°F

Depth

Flow 5 gpm

3 springs

With this temperature there is a possibility of greenhouse and aquaculture operation, resort/spa facility, space heating and industrial applications. We have no listing of geothermal being used in the area.

Harney

Temp 161°F

Depth 941 ft

Flow 264 gpm

2 wells

With this temperature there is a possibility of greenhouse and aquaculture operation, resort/spa facility and maybe space heating. We have no listing of geothermal being used in the area.

Lawen

Temp 136°F

Depth 1834 ft

Flow 9 gpm

2 wells

With this temperature there is a possibility of greenhouse and aquaculture operation, resort/spa facility and maybe space heating. Lawen is located between Burns and Crane but have not geothermal use activity listed in the area.

Klamath County

Bonanza

Temp 201°F

Depth 230 ft

No flow listed

2 well

With this temperature there is a possibility of greenhouse and aquaculture operation, resort/spa facility, space heating and industrial applications.

Lorella

Temp 142°F

Depth

Flow 40 gpm

2 well

With this temperature there is a possibility of greenhouse and aquaculture operation, resort/spa facility, space heating and industrial applications. There is some space heating in Langel Valley which is part of the Bonanza area.

Klamath Falls

Temp 221°F

Depth 656 ft

Flow 2213 gpm

Over 550 wells

With this temperature there is a possibility of greenhouse and aquaculture operation, resort/spa facility, space heating and industrial applications. Klamath Falls has technically 4 district heating systems (OIT, City, hospital, Vandenberg complex), numerous space heating applications, aquaculture operation, pool heating, greenhouse operation, biodiesel plant, industrial application (growing mites) and snow melting. Klamath Hills and Olene Gap were not included in the collocated database for they are over 5 miles from Klamath Falls.

Lake County

Adel

Temp 250°F

Depth 643 ft

Flow 16 gpm

3 wells and one spring

With this temperature there is a possibility of greenhouse and aquaculture operation, resort/spa facility, space heating and industrial applications. These are all associated with the crump geyser area. The hottest well (250°F) is Crump Geyser. We have no information if geothermal is being used in the area.

Lakeview

Temp 235°F

Depth 607 ft

Flow 1727 gpm

32 wells and 4 springs

With this temperature there is a possibility of greenhouse and aquaculture operation, resort/spa facility, space heating and industrial applications. Lakeview is looking at developing an industrial park and also a district heating system. There is also a prison being heated with the geothermal, also greenhouse, resort, residential space heating and swimming pool.

New Pine Creek

Temp 192°F

Depth 560 ft

Flow 3963 gpm

4 wells

With this temperature there is a possibility of greenhouse and aquaculture operation, resort/spa facility, space heating and

industrial applications. We have no information if geothermal is being used in the area.

Paisley / Summer Lake

Temp 231°F

Depth 689 ft

Flow 20 gpm

5 wells and 1 spring

With this temperature there is a possibility of greenhouse and aquaculture operation, resort/spa facility, space heating and industrial applications. Geothermal is being used now for space heating, aquaculture and pool heating at Summer Lake.

Paisley is having a feasibility study done to see if they can generate power and also cascade the use for industrial and space heating applications.

Jackson County

There are no wells in the database with a temperature over 122°F. Although there is some geothermal use in Ashland with a greenhouse and pool heating at Jackson Hot Springs

Lane County

McCredie Springs

Temp 163°F

Depth

Flow 20 gpm

1 spring

With this temperature there is a possibility of greenhouse and aquaculture operation, resort/spa facility and maybe space heating.

McKenzie Bridge

Temp 192°F

Depth 426 ft

Flow 104 gpm

2 wells and 3 springs

With this temperature there is a possibility of greenhouse and aquaculture operation, resort/spa facility, space heating and industrial applications. The three springs are Bigelow, Belknap and Foley. Belknap uses it for space and pool heating.

Found out a spring (Foley?) in the area is being used for space heating.

Linn County

Jefferson

Temp 136°F

Depth 4915 ft

No flow listed

1 well

With this temperature there is a possibility of greenhouse and aquaculture operation, resort/spa facility and maybe space heating. This was an oil and gas test well. We have no information if geothermal is being used in the area.

Malheur County

Adrain

Temp 174°F

Depth 1345 ft

Flow 16 gpm

4 wells and 3 springs

With this temperature there is a possibility of greenhouse and aquaculture operation, resort/spa facility and maybe space heating. This included Deer Butte and Snively Hot Springs. We have no information if geothermal is being used in the area.

Beulah

Temp 140°F

Depth

Flow 13 gpm

1 spring

With this temperature there is a possibility of greenhouse and aquaculture operation, resort/spa facility and maybe space heating. We have no information if geothermal is being used in the area.

Harper / Little Valley

Temp 158°F

Depth 410 ft

Flow 145 gpm

2 wells and 1 spring

With this temperature there is a possibility of greenhouse and aquaculture operation, resort/spa facility and space heating. There was an aquaculture/greenhouse operation there but not sure if it is still operating. The owner was trying to sell the property at one time.

Nyssa

Temp 183°F

Depth 1568 ft

No flow listed

1 well

With this temperature there is a possibility of greenhouse and aquaculture operation, resort/spa facility, space heating but marginal for industrial applications. This was an oil and gas test well. We have no information if geothermal is being used in the area.

Ontario

Temp 334°F

Depth 10,052 ft

No flow listed

1 well

With this temperature there is a possibility of greenhouse and aquaculture operation, resort/spa facility, space heating and industrial applications. This is the well that was drilled on Ore-Ida property for possible industrial use, but there was no water. We have no information if geothermal is being used in the area.

Riverside

Temp 145°F

Depth

Flow 59 gpm

1 spring

With this temperature there is a possibility of greenhouse and aquaculture operation, resort/spa facility and space heating. We have no information if geothermal is being used in the area.

Vale

Temp 239°F

Depth 266 ft

Flow 770 gpm

32 wells and 1 spring

With this temperature there is a possibility of greenhouse and aquaculture operation, resort/spa facility, space heating and industrial applications. This area uses geothermal for industrial (mushroom growing), space heating, and corn drying in a mini district heating system.

Marion County

Breitenbush Hot Spring / Idanha

Temp 192°F

Depth 1017 ft

Flow 900 gpm

6 wells and 1 spring

With this temperature there is a possibility of greenhouse and aquaculture operation, resort/spa facility, space heating and industrial applications. Most of the geothermal is located at Breitenbush and they use it for space and pool heating.

Silverton / Scott Mills

Temp 162°F

Depth 7805 ft

No flow listed

1 well

With this temperature there is a possibility of greenhouse and aquaculture operation, resort/spa facility and space heating. We have no information if geothermal is being used in the area. This was an oil and gas test well.

Umatilla County

Lehman Springs

Temp 142°F

Depth

No flow listed

1 spring

With this temperature there is a possibility of greenhouse and aquaculture operation, resort/spa facility and maybe space heating. The spring is used for pool heating. There is not information on other geothermal use in the area.

Union County

Pondosa / Medical Springs

Temp 142°F

Depth

Flow 53 gpm

1 spring

With this temperature there is a possibility of greenhouse and aquaculture operation, resort/spa facility and maybe space heating. We have space heating listed for medical hot springs

Union / Cove

Temp 185°F

Depth

Flow 1626 gpm

2 wells and 2 springs

With this temperature there is a possibility of greenhouse and aquaculture operation, resort/spa facility, space heating and industrial applications. This area includes Hot Lake Resort, Cove greenhouse and swimming pool. Last I read the owners are in the process of renovating Hot Lake but I am not sure what all they use the geothermal for at this time.

Wasco County

Kehneeta

Temp 133°F

Depth

No flow listed

3 springs

With this temperature there is a possibility of greenhouse and aquaculture operation, resort/spa facility and maybe space heating. The resource mentioned above is located in the Warm Springs reservation and they use it for pool heating and some space heating

Possible power generation locations using 170°F or above water.

Government Camp

Austin Hot Springs

Breitenbush

Kahneeta

Belknap Hot Springs

Klamath Hills

Klamath Falls

Summer Lake

Lakeview

Crane Hot Springs

Olene Gap

Langell Valley

New Pine Creek

Ontario

Nyssa

Adrain

Marion County

Union

Adel (Crump Geyser)

Fields (Alvord Desert)

Vale

Geo-Heat Center Bulletin Articles and Case Studies of Direct Uses and Heat Pump Operations

“Chill Out” – Oregon Institute of Technology is a Winner
The Oregon Institute of Technology Geothermal Heat System – Then and Now
Klamath Falls Geothermal District Heating System at 25 years
From Creamery to Brewery with Geothermal Energy: Klamath Basin Brewing Company
New Greenhouses in Klamath Falls
New Snow Melt Projects in Klamath Falls, OR
“Gone Fishing” Aquaculture Project – Klamath Falls, Oregon
Greenfuels of Oregon: Geothermal Energy Utilization in Biodiesel Production
Oregon Trail Mushrooms
Chiloquin Community Center – Chiloquin, Oregon
Residential Downhole Heat Exchanger – Klamath Falls, Oregon
Merle West Medical Center – Klamath Falls, Oregon
Klamath County Vandenberg Road Complex
REACH, Inc. Juniper Processing Plant - Klamath Falls, Oregon
Inn of the Seventh Mountain - Bend, Oregon

Geothermal Technologies Program Oregon Factsheet

Geo-Heat Center Publication for Oregon

"CHILL OUT" - OREGON INSTITUTE OF TECHNOLOGY IS A WINNER

John W. Lund and Toni Boyd, Geo-Heat Center, Oregon Institute of Technology

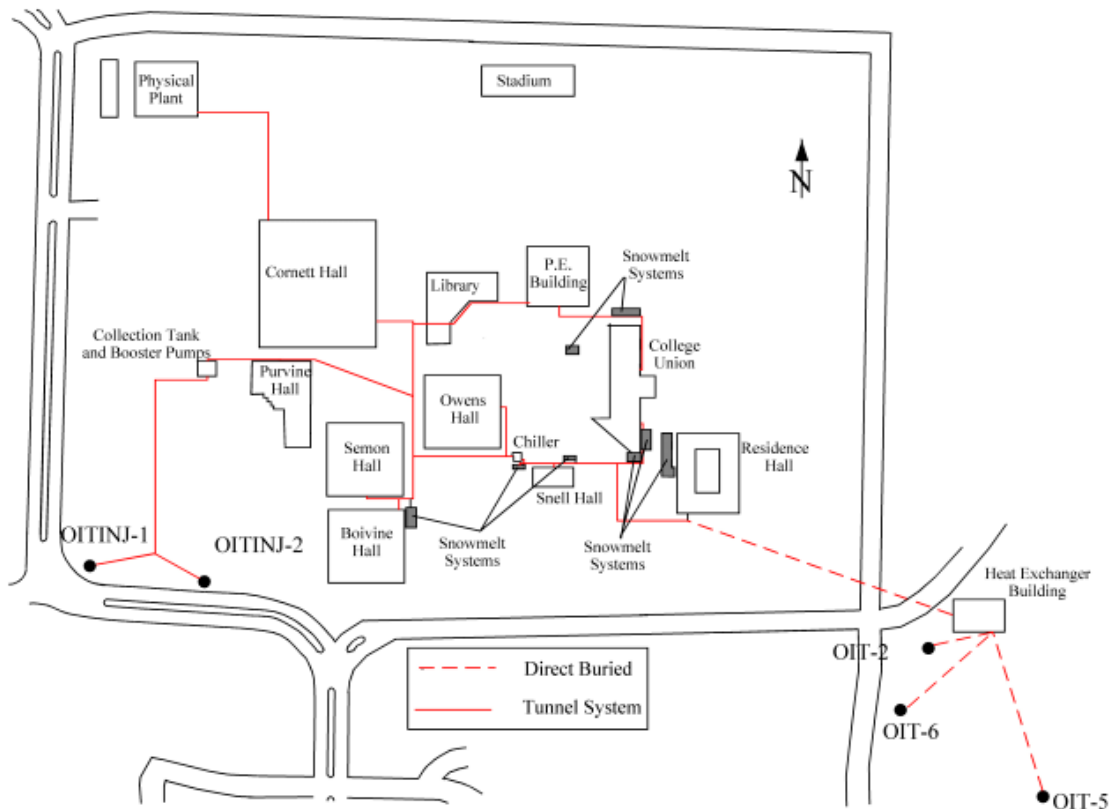

OIT's geothermally heated fountain.

The National Wildlife Federation (NWF) hosted the first annual national competition called "Chill Out! Campus Solutions to Global Warming" with their partners, the Earth Day Network, Campus Climate Challenge and the Society for College and University Planning. The nation-wide contest was held throughout the fall and winter of the 2006-2007 school year. The "Chill Out" competition seeks to advance and celebrate the innovators of global warming solutions on college and university campuses all across the country. The purpose of the contest was to spotlight solutions to global warming on campuses and to share these with a national audience. Students, faculty or staff could either submit a short

written blurb on the contest entry website or a short video segment on the linked YouTube site. Details on the contest can be found at www.nwf.org/chillout (you can also access the contest through NWF's Campus Ecology website at www.nwf.org/campusecology).

The following is what John Lund submitted to the contest:

**"CHILL OUT!
CAMPUS SOLUTIONS TO GLOBAL WARMING"
OREGON INSTITUTE OF TECHNOLOGY
3201 CAMPUS DR.
KLAMATH FALLS, OR 97601**

Oregon Institute of Technology, a state college of the Oregon University System, was founded in 1947. Due to high energy costs on the original campus, a new campus was constructed to take advantage of geothermal energy that was known to exist in the community. In the early 1960s, three deep wells were drilled tapping geothermal hot water at 192°F (89°C). This hot water now heats the entire campus of about 650,000 sq. ft. (60,000 sq. m) saving about \$1,000,000 annually in heating and domestic hot water costs. No other source of energy is available for heating thus; the campus is entirely energy independent of fossil fuel sources. The campus also uses the geothermal energy for melting snow on stairs and handicap ramps. The installed capacity of this system is 6.2 MWt and the annual energy use is about 47 billion Btus (14 GWh), saving 10,000 tonnes of CO₂ emissions annually (compared to producing it from petroleum).

This year, the campus administration is proposing to drill a well (5,000 to 6,000 ft – 1,500 to 1,800 m) deep into a fault that is known to have a geothermal resource around 300°F (150°C), to generate electricity. If this is successful, a one megawatt (MWe) geothermal power plant of either a flash steam or binary type will be installed to provide all the electricity needs on campus. This will provide an additional savings of around \$500,000 and reduce CO₂ emissions by about 16,000 tonnes annually (compared to producing it from petroleum). The campus would then be 100% “green” by producing all of its energy needs from geothermal resources.

In addition, the campus will construct a geothermally heated greenhouse and aquaculture facility to train interested students and potential developers in the use of geothermal energy for agricultural purposes.



Snow melted stairs.

The Geo-Heat Center was established on campus in 1974 to provide information dissemination and technical assistance for persons and organizations nation-wide and internationally to develop and utilization geothermal energy (website: <http://geoheat.oit.edu>). The Center staff also provides tours of the campus and community geothermal uses to educate students and interested investors in the benefits of geothermal energy, as well as assisting in the development of the geothermal uses. The proposed power plants, greenhouse and aquaculture facilities will also be used as a training facility and showcase to help transfer geothermal use to other locations throughout the country. Even though, high temperature geothermal energy is generally only available in the western states, the Geo-Heat Center also provides information and training in geothermal (ground-source) heat pumps that can be installed anywhere in the country as they only require normal ground and ground-water temperature to be utilized for both heating and cooling. Our staff of four people has provided technical assistance on geothermal energy use to every state in the Union and well as over 50 countries.

In March 2007, the winning campuses of the contest were notified. In addition to grants and other prizes, winning campuses were to be featured in a national broadcast on the week of Earth Day (on April 18, 2007 at 3:00 eastern). Oregon Institute of Technology was one of the eight winners, and was requested to participate in a live webcast in Washington, D.C. on April 18, 2007. The other winning campus were California State University, Chico; Mount

Wachusett Community College, Gardner, Massachusetts; Monmouth, West Long Branch, New Jersey; Richard Stockton College, Somers Point, New Jersey; University of California at Santa Barbara; Oberlin College, Oberlin, Ohio; and Lawrence School, Lawrence, New Jersey.

The National Wildlife Federation video team visited campus in March and filmed an interview with President Martha Anne Dow, Geo-Heat Center Director, John Lund, and Geo-Heat Center Engineer and OIT graduate Toni Boyd. They also filmed various geothermal uses on campus. This short video can be viewed on the National Wildlife Federation website: www.nsf.org/chillout.

The live “Chill Out” webcast which was broadcast to over 160 college campuses throughout the country brought together thousands of college students, faculty and staff to celebrate real and practical solutions to global warming taking places on colleges today. It featured a special message from Al Gore to colleges and universities, the winning campuses and an interactive panel of sustainability heroes.

Toni Boyd, of the Geo-Heat Center, represented the campus at the live webcast in Washington, D.C. on April 18. She participated in one of two panel discussions during the live webcast with the other seven winners.

According to NWF, the nation’s over 4,000 colleges and universities manage over 5 billion ft² of space and spend approximately \$18 billion annually on energy costs and emit more than 19 million metric tons of CO₂ annually. The NWF estimated that the winning schools saved approximately \$6 million annually along with eliminating over 20,000 tons (40 million pounds) of CO₂ from the atmosphere. Table 1 shows the conservative estimate made by NFW of CO₂ and cost savings.

Table 1. NWF Estimated CO₂ and Cost Savings

Campus	CO ₂ Reduction Annual Tons	Annual Savings
California State University - Chico	100	\$100,000
Mt. Wachusett CC	1,909	\$500,000
Monmouth University	166	\$150,000
Richard Stockton College		\$433,500
Oregon Institute of Tech	11,000	\$1,000,000
University of California - SB	8,150	\$3,700,000
Oberlin College	140	\$66,000
Lawrenceville School (HS)	199	
Totals	21,664	\$5,949,500

The eight winners and a brief explanation of their written blurb, from NWF website, follow:

California State University—Chico, CA: Chico State has committed to focusing on institutionalizing sustainability into the education of students. Two buildings are registered

with LEED, and all new buildings constructed will meet LEED silver requirements. A 300 kW solar array was installed on two campus rooftops. Students have taken the lead to promote sustainability on campus, through projects such as: creating a student fee to fund sustainability projects, retrofitting a residence hall, networking with the Chico community to create sustainability service learning programs, and installing energy saving software on computers.

Mount Wachusett Community College, Gardner, MA:

The college conversion of its all-electrical campus to a bio-mass hydronic district heating system has drastically reduced GHG emissions. This conversion demonstrates the use of a sustainable and locally available feedstock and provided unique educational opportunities for students. This project, along with conservation measures, has resulted in a 24% reduction of GHG over the past four years. MWCC has a cumulative water savings of 12.2 million gallons. By eliminating electricity as a heat source, MWCC has reduced electricity use by 45.97% and saved \$2 million. Four new renewable energy courses are in place. The College is coordinating with 11 states to encourage the use of biobased fuels. The College will soon install a 100kW PV array.

Monmouth University, West Long Branch, NJ: The University was just named 2006 New Jersey “Clean Energy School of the Year” after entering a statewide competition. Monmouth completed the largest solar installation east of the Mississippi in summer 2006. The solar panels will save \$150,000 and 468,569 kWh/yr. The solar system covers 33,000 ft² on roofs of four campus buildings. To engage students, there is a computer generated station that shows energy conservation data in “real time” from the panels. Students were also involved in installing the solar panels.

Richard Stockton College, Somers Point, NJ: Projects include the world’s largest closed-loop geothermal heating and cooling system, solar PV arrays, and a 200 kW fuel cell. The geothermal unit reduces the school’s electric consumption by 25% and natural gas consumption by 70%. The unit has decreased the college’s CO₂ emission by 13% since 1990 and saves the school \$330,000 annually. The fuel cell was installed in 2002, and provides 10% of the total energy for the campus. The fuel cell is centrally located on campus and is covered in explanatory diagrams making it a teaching tool for students, faculty, staff and other professionals. The PV array (18kW) saves the college \$3,500 a year.

Oregon Institute of Technology, Klamath Falls, OR: Due to the high energy costs on the original campus, a new campus was constructed to take advantage of geothermal energy that was known to exist in the community. In the early 1960s, three deep wells were drilled tapping geothermal hot water. This hot water now heats the entire campus of 650,000 sq. ft., saving about \$1,000,000 annually in heating and hot water costs. The Geo-Heat Center was established on campus in 1974 to provide information and technical assistance for people and organizations to develop and utilize geother-

mal energy, while also providing tours to the campus and community. The campus administration is proposing to drill a well into a fault to generate 100% of the campus’s electricity and construct a geothermally heated greenhouse and aquaculture facility to train individuals. The proposals will be used as a training facility and showcase. The staff of four people has provided technical assistance on geothermal energy use to every state in the Union as well as over 50 countries.

University of California, Santa Barbara, CA: In 2005, students from the Bren School of Environmental Science and Management created a Master’s group project entitled “Campus Climate Neutral” and sought to write their thesis on the feasibility of a carbon-neutral campus. One recommendation of this study was the certification of the campus’s CO₂ emissions through the California Climate Action Registry. As a public university dealing with tightening budgets, Facilities began to implement energy conservation. Campus-wide lighting retrofits, motion sensors, efficient chillers, and variable frequencies, and efficient chillers are several projects that USCB initiated, resulting in a reduction of CO₂ by 8,100 tons per year. To educate the campus, Facilities operates sustainability and energy specific websites. In addition, the Green Campus Program runs the “Energy Conservation Competition” in residence halls, pitting halls against one another to lower energy use.

Oberlin College, Oberlin, OH: A group of students and a professor developed the “Campus Resource Monitoring System” (CRMS)—an automated monitoring system and website that gathers, processes and displays data on energy and water use in dormitories. The premise is that real-time data can be used to education, and motivate students to conserve resources. For a two week period in 2005, dorms competed to see who could reduce consumption the most, getting 80% of the student body to participate. During that period, students conserved 68,000 kWh, saving \$5,100, and reducing emissions by 150,000 lbs of CO₂. A conservative estimate is that CRMS will save Oberlin \$66,000/yr in electricity costs.

The Lawrenceville School (High School), Lawrence, NJ: Students for Environmental Leadership Coalition (SELF) is promoted the Green Cup Challenge, an inter-scholastic energy saving competition between 15 Northeastern boarding schools. Last year was the first year of the Green Cup Challenge, where three schools participated saving 398,370 lbs of CO₂. This year the plans are to increase the program substantially. SELF made a school-wide presentation regarding global warming and events for the month to promote the Challenge. Projects on campus involve a student biodiesel manufacturing group and the beginnings of an organic garden to provide food for a dining hall.

The event and award is certainly an honor for our campus, and was the only submittal featuring direct-use geothermal energy.

THE OREGON INSTITUTE OF TECHNOLOGY GEOHERMAL HEATING SYSTEM - THEN AND NOW

Tonya L. Boyd
Geo-Heat Center

INTRODUCTION

Oregon Institute of Technology (OIT) is located on a hill, which gently slopes from the east to the west, in the north-east part of Klamath Falls. The campus has been using geothermal water, for its heating and domestic hot water needs, since it was relocated to this location in 1964. It has been in continuous operation for 35 years and now heats 11 buildings (~600,000 ft² / 55,700 m²). It is the oldest of the modern geothermal district-heating systems, and due to the lack of experience with the design of large systems in the early-1960s, it has experienced some difficulties through the years. These difficulties have been resolved and the experience has provided a substantial body of information concerning the applicability of various materials and designs for low-temperature use.

The original system, which provided heating and domestic hot water for the five original buildings, consisted of constant-speed, water-lubricated lineshaft pumps located in well pits. The pumps were run manually according to the level in the storage tank. The distribution system consisted of direct-buried Schedule 40 carbon steel piping which was field insulated with "Foamglas" type insulation and covered with a "mastic" vapor barrier. The geothermal water was used di-

rectly in the buildings' mechanical heating systems; then, the effluent was disposed of to the surface through the storm drainage system than eventually emptied into Upper Klamath Lake. Cooling for the campus was accomplished by an electric-powered chiller.

Figure 1 shows a general layout of the OIT system as it is today. Geothermal water for the system is produced from three wells at a temperature of 192°F (89°C), which are located in the southeast corner of the campus. The wells are from 1300-1800 ft (400-550 m) in depth. The water is pumped individually from each well (total flow of all the wells is 980 gpm/62 L/s). The water is then collected in a 4000-gal (15-m³) settling tank in the Heat Exchanger building before it is delivered to each building via gravity through the distribution system according to demand on the system. The settling tank (Figure 2) provides the necessary head for the gravity flow system and allows the fines from pumping to settle out of the water. The heat exchanger building also housed a fuel-oil boiler from the old campus as a backup; but due to lack of use, it was dismantled several years ago. The geothermal system saves approximately 11,000 bbl (1650 tonnes) of oil or \$225,000 each year.

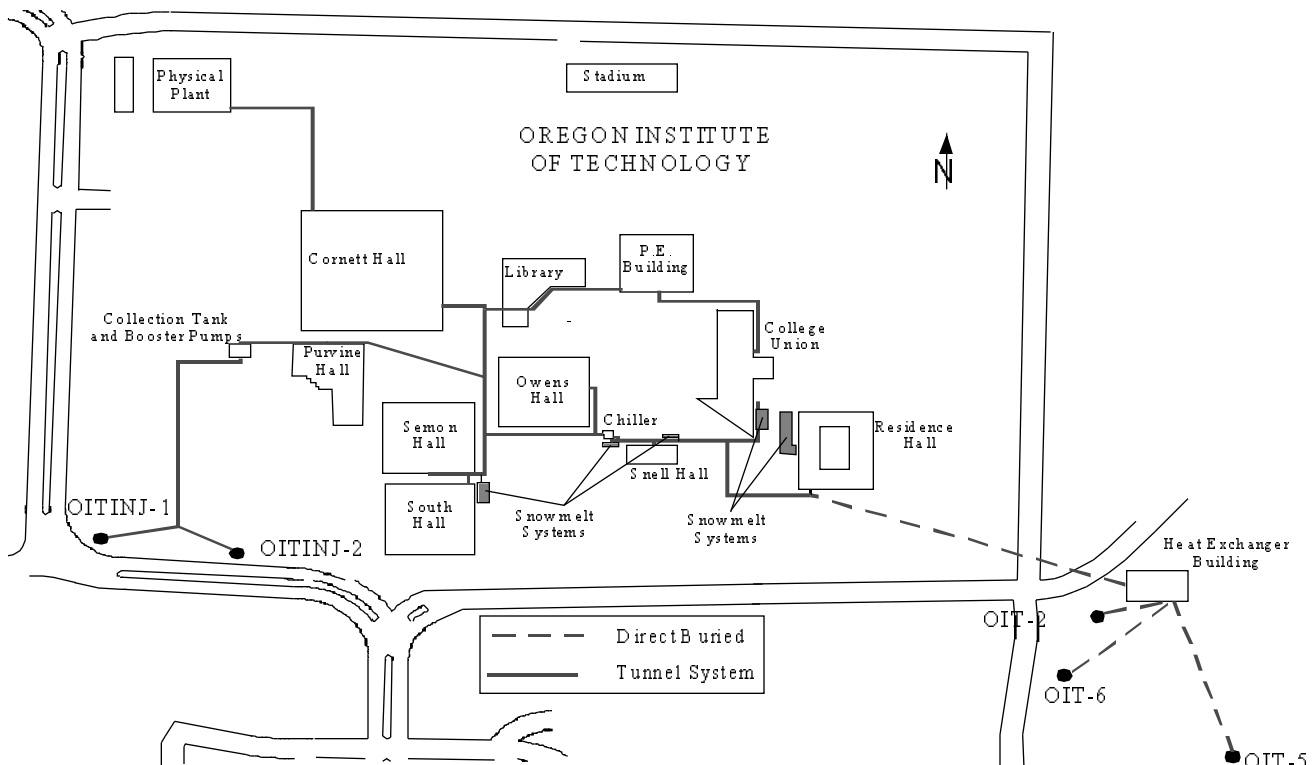

Figure 1. General layout of the OIT geothermal system.

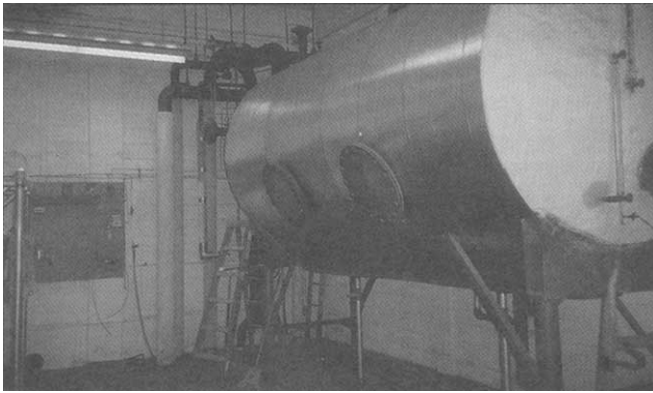

Figure 2. The 4000-gal (15-m³) settling tank located in the Heat Exchanger building.

THE PROBLEMS ENCOUNTERED AND THE SOLUTIONS

Pumps

After approximately six years of operation, a major redesign of the pumping system was carried out. The original constant-speed, water-lubricated lineshaft pumps, were virtually the same as cold-water irrigation pumps and were located in wellhead pits. Placing the pumps in the pits didn't allow for air circulation which lead to overheating and condensation problems. The earlier pumps also didn't provide for the expansion of the piping in the well; therefore, the lineshaft had to be pre-heated to produce sufficient clearance before the pump was started. This meant one pump had to be kept running all the time. The pumps also experienced other failures. The original bronze impellers were attached to the shaft with collets and the failures occurred when the impellers detached from the shaft. The most serious problem was related to the failure of the shaft bearings. A number of bearing types were used, but none proved to have acceptable lifetimes. It was reported that the bronze bearings "burned up," and the rubber and teflon bearings "swelled."

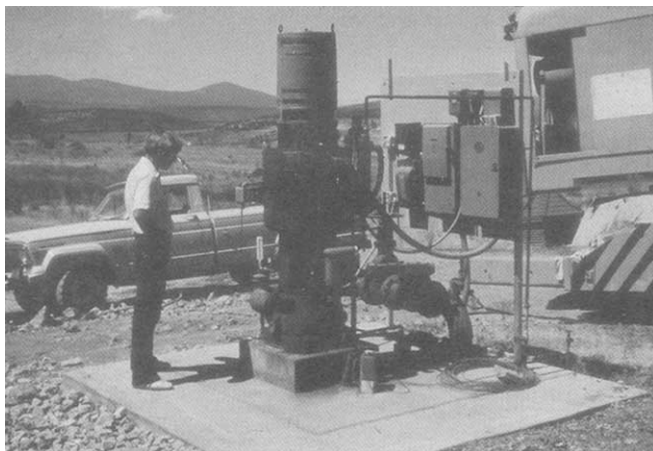

Figure 3. One of the pumps and variable-speed controllers with the housing removed.

During the redesign of the pumps, extra lateral bowls were installed to eliminate the need for shaft preheating. The impellers were attached with both keys and collets. At this point, it was also decided to isolate the bearings from the geothermal water using an oil-lubricated enclosed lineshaft arrangement. To help with the overheating and condensation problems, it was decided to raise the pumps to ground level and enclosed them in housing (Rafferty, 1989). Figure 3 shows one of the pumps with the housing removed.

Distribution System

The original distribution system consisted of direct-buried Schedule 40 carbon steel piping, field insulated with "Foamglas" insulation and covered with a "mastic" vapor barrier. This piping system suffered internal and exterior corrosion. The external corrosion was due to the expansion and movement of piping which caused the mastic vapor barrier to break. This failure allowed groundwater and salt water from deicing to come in contact with the piping, resulting in the external corrosion. After 14 years of service, an examination of the piping revealed an internal buildup of scale. The scale consisted of mainly silica and iron oxide with the iron oxide being closest to the pipe. In many places, the piping wall thickness was reduced to one-third of its original thickness. The fact that the main settling tank was vented to the atmosphere permitted oxygen to enter the system, which promoted the internal corrosion. The storm sewer system used for disposal of the effluent also encountered failures. This part of the system consisted of cast iron and carbon steel piping located in the buildings, galvanized culverts from the buildings to the main line, and concrete culverts in the main line. All of the failures occurred in sections with galvanized culverts. This could have been a result of dezincification (galvanized coating removed) and eventually corrosion of the unprotected steel surface (Rafferty, 1989).

In response to the piping failures, it was decided to construct a new distribution system and a dedicated collection system along with the construction of utility tunnels to connect all the buildings. The design of the tunnel (6 ft x 6 ft / 2 m x 2 m) provides access for maintenance personnel and space for other campus utilities. During construction the concrete was formed and poured in place to allow for forming around building foundations and utility pipes running at an angle to centerline (Figure 4). The floor of the tunnel is 8 in. (20 cm) thick and the sides 6 in. (20 cm) thick. The pipes are held to the side with pipe clamps and Unistrut hangers. In some cases, the tunnel also serves as a sidewalk; thus, snow-melting is enhanced due to the heat loss through the system. The cost of constructing the tunnel system (including excavation and backfill) was extremely high at about \$160/lf (\$525/m), which didn't include the cost of the piping. The cost of the piping varied from \$15/ft (\$50/m) for 6-in. (15-cm) diameter to \$22/ft (\$72/m) for 8-in. (20-cm) diameter pipe. When new extensions to the tunnel system were added, a 6-ft (2-m) diameter corrugated galvanized steel culvert was used instead of concrete. Its estimated cost was only 25 percent of the cost for concrete tunnels (Lund and Lienau, 1980).



Figure 4. View of the tunnel under construction.

Heat Exchangers

In the original design, the geothermal water was used directly in each of the building mechanical systems. This “once through” approach eliminated the need for circulation pumps in the buildings. The direct use of the geothermal fluids caused problems due to the corrosive nature of the water. The original chemical analysis of the water failed to consider the effect of H_2S (hydrogen sulfide) and NH_4 (ammonia) on the copper and copper alloys used in the mechanical system. There were a number of different types of failures identified that occurred as a result of using the water directly. The most important ones are listed below:

- Failure of the 50/50 tin/lead solder connections,
- Rapid failure of 1% silver solder,
- Wall thinning and perforation of copper tubing was a common occurrence,
- Control valve failures where plug (brass) was crimped to the stem (stainless steel). The threaded ones experienced no problems, and
- Control valve problems associated with packing leakage.

To address these problems, it was decided to isolate the geothermal water from the building heating systems using plate heat exchangers. Based on an analysis study, heat exchangers with 316 stainless steel plates with Buna-N gaskets were selected. The stainless steel heat exchanger used to heat the campus swimming pool failed within the first three years of operation. This failure occurred on the pool’s water side of the heat exchanger, probably as a result of the high chorine content. The pool’s heat exchanger was eventually replaced with titanium plates (Rafferty, 1989).

Some of the building systems utilize two loops through the heat exchanger. The College Union building plate heat exchanger, shown in Figure 5, utilizes two loops. The first loop provides 1,350,000 Btu/hr (1,350 MJ/hr) using the geo-

thermal water at 100 gpm (6.3 L/s) and the building water at 54 gpm (3.4 L/s). The building water is then circulated through finned-tube pipe heat convectors located along the outside walls of the building. The second loop provides 30,000 Btu/hr (30 MJ/hr) using geothermal water at 25 gpm (1.4 L/s) and building water at 12 gpm (0.65 L/s). The building water is then circulated through reheat coils, which provides heating through a forced-air system for the interior of the building (Lund and Lienau, 1980).

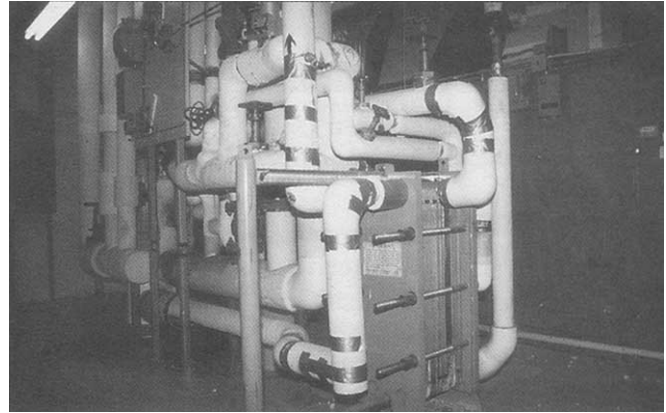

Figure 5. The College Union heat exchanger.

Fluid Disposal

Discharge to the surface was the original approach for disposal of the geothermal effluent. Although surface discharge is the simplest and least expensive option, there were several possible potential problems. The discharge temperature of the waste effluent was still quite high (135°F/57°C-winter and 170°F/77°C-summer) when it was delivered to the ditch. This method presented a safety hazard. A local city ordinance was passed which banned surface disposal and required all operations in the city to establish an injection program by 1990. OIT now has two injection wells to comply with the ordinance. The first injection well was drilled using standard mud-rotary techniques, and the second well used a combination of methods with air drilling in the injection zone. During the initial pumping test of the first injection well, the maximum obtainable pumping rate was only 200 gpm (12.6 L/s). It was believed that a considerable amount of drilling mud had invaded fractures in the primary production zones. The well was acidized (13% hydrochloric acid, 3% hydrofluoric acid) twice; this increased the capacity from 200 to 400 gpm (12.6 to 25.2 L/s). Analysis of test data indicated that the aquifer was still clogged with drilling mud at about 25 times the effective radius of the well. The maximum injection rate was estimated to be 600 gpm (37.8 L/s). The second injection well easily handles 1,000 gpm (63 L/s) and could possibly accept as much as 2,500 gpm (158 L/s) at 50 psi (3.4 bar) injection pressure is allowed at the wellhead. This well is being used as the primary injection well. Experience with these injection well suggest that air drilling can be quite beneficial in terms of subsequent well performance (Lienau, 1989).

NEW ADDITIONS TO THE SYSTEM

Snowmelt System

The newest additions to the OIT system are two sections of sidewalk snowmelting located by the Residence Hall. This brings the total amount of sidewalk snowmelting to 2,300 ft² (214 m²). The other sections include the wheelchair ramp in front of South Hall and a couple of stairwells (Figure 6) leading to upper sections of the campus. All systems utilize 5/8-in. (1.6 cm) diameter cross-linked polyethylene tubing (PEX). The wheelchair ramp has four loops with the tubing spaced 10 in. (25 cm) apart. The stairs has three loops with the tubing tied to the existing stairs. Figure 7 shows the placement of tubing on a stairwell before the form work was added. The systems should be able to maintain a slab surface temperature of 38°F (3°C) at -5°F (-21°C) air temperature and 10 mph (16 km/h) wind when the entering 50/50 propylene glycol/water temperature is 144°F (62°C). Each stair section uses a brazed-plate heat exchanger to isolate the glycol-filled snowmelt loop. The new snowmelt systems installed have slab temperature sensors which will activate the system when the outside air is 30°F (-1°C) (Geothermal Pipeline, 1994).



Figure 6. One of the stairwell leading to the College Union.



Figure 7. Placement of the snowmelt tubing before the formwork was added.

Purvine Hall

Purvine Hall utilizes the geothermal waste effluent from the rest of the campus for its space heating and domestic hot water heating. The temperature of the effluent as it enters the building is around 155°F (68°C) and leaves at a temperature of around 130°F (54°C). The main components of heating system include a 4,000-gal (15-m³) storage tank, circulation pumps and heat exchangers. On the building heating side, space heating is accomplished by 54 variable air volume terminals equipped with hot water coils (Fields, 1989).

Absorption Chiller

A lithium-bromide absorption chiller was installed in 1980. It has a nominal 312 ton (1095 kW) capacity; but due to the low temperature of the water entering the system (192°F/89°C), it only produces 150 tons (526 kW) of cooling. The chiller requires 685 gpm (37.8 L/s) of geothermal fluid and only takes a 20°F (11°C) delta T out of the water. Recorded installation cost for the chiller was \$171,300. The geothermal chiller supplies a base cooling load to five campus buildings or 277,300 ft² (25,800 m²). The original electrical centrifugal chiller is now being used for peaking above the capacity of the absorption chiller. Since the geothermal water is used directly in the generator tubes of the absorption chiller there is a potential for corrosion to occur. The generator tubes are constructed of 90-10 cupro-nickel; but, no failures have occurred in the past 18 years (Lund and Lienau, 1980). Due to the low efficiency and high water usage, the absorption chiller will be replaced this summer with a centrifugal water chiller.

REFERENCES

- Fields, Paula G., 1989. "Purvine Hall Geothermal Heating System," *Geo-Heat Center Quarterly Bulletin*, Vol. 11, No. 4, pp. 16-17.
- Geothermal Pipeline, 1994. "Geothermal Wheelchair Ramp Installed at OIT," *Geo-Heat Center Quarterly Bulletin*, Vol. 16, No. 1, pp. 24-25.
- Lienau, Paul, 1989. "OIT Injection Well," *Geo-Heat Center Quarterly Bulletin*, Vol. 11, No. 4, pp. 9-11.
- Lund, John W. and Paul J. Lienau, 1980. "New Geothermal Construction on the OIT Campus," *Geo-Heat Center Quarterly Bulletin*, Vol. 5, No. 3, pp. 21-23.
- Rafferty, K. 1989. "A Materials and Equipment Review of Selected U.S. Geothermal District Heating Systems." *Geo-Heat Center*, Klamath Falls, OR. USDOE Contract # DE-FG07-87-ID 12693.
- Gibson, Raymond, 1999. Personal communication. Oregon Institute of Technology.
- Masl, Bruce, 1999. Personal communication. Oregon Institute of Technology.

Klamath Falls Geothermal District Heating System at 25 Years

Brian Brown P.E., Brian Brown Engineering, Klamath Falls, OR



Figure 1. Klamath Falls Geothermal District Heating system location map, 2005

ABSTRACT

In 1976 the OIT Geo-Heat Center began investigating the feasibility of developing a geothermal district heating system to serve the Klamath Falls downtown. The district heating system was installed in 1981. Startup and operational problems prevented reliable operation until 1991. In 1992, the city began marketing the district heating system to other buildings in the downtown area.

By 2006 the system approached the original design capacity, and more growth is planned. After 25 years, the system is beginning to realize the economic benefits envisioned by the original feasibility studies in 1977.

INTRODUCTION

The City of Klamath Falls, Oregon, is located in a Known Geothermal Resource Area (KGRA) that has been directly used to heat homes, businesses, schools, and institutions since the early 1900s. In 1976, Klamath Falls and Klamath County became interested in establishing a geothermal district heating system to extend the benefits of the geothermal resource to government buildings and businesses in downtown Klamath Falls. This led to construction of the district heating system in 1981. After a difficult start-up period, the

system has provided reliable service since 1991. For more information on the system development, see Lienau, et al., (1989 and 1991).

The district heating system was originally designed for a thermal capacity of 20 million Btu/hr (5.9 MWt). At peak heating, the original ten buildings on the system utilized only about 20 to 25 percent of the system thermal capacity.

Total annual heating revenue from those buildings in 1991 was about \$23,800, which was inadequate to sustain system operation. This led the city to begin a marketing effort in 1992 to add more customers to the system (Rafferty, 1993).

The Klamath Falls geothermal district heating system currently serves process heating at the Klamath Falls wastewater treatment plant (WWTP), 24 buildings totaling about 400,000 sq. ft., greenhouses totaling 150,000 sq. ft., and about 105,000 sq. ft. of sidewalk snowmelt systems. Figure 1 shows the existing district heating service area.

The year 2006 marked 25 years since completion of the district heating system construction. This paper is intended to provide a retrospective on system development and lessons learned. The author has provided geothermal engineering consulting to the city since 1992.

District Heating System Timeline

- 1977: Feasibility study. (Lienau, et al., 1977).
- 1981: Construction of downtown district heating system completed.
- 1982: Construction of Michigan Street district heating system to serve low income neighborhood of 120 homes, funded by HUD. Only about 10 homes connected.
- 1981-1984: Public opposition delayed operation of the system until an aquifer study was completed.
- Nov. 1984: System operation begins.
- Feb. 1986: System operation halted after multiple failures of the distribution piping.
- Jan. 1991: System operation restarted after reconstruction of distribution piping.
- 1992: Beginning of marketing effort to add customers (Rafferty, 1993).
- Sep. 1993: Earthquake damages four County buildings, about half of connected heating load shut down.
- Nov. 1993: Pipeline extension to the Ross Ragland Theater completed; allows connection of six new customers.
- 1995-1998: Development of the Klamath Falls Main Street streetscape project, with geothermally heated sidewalks and crosswalks (Brown, 1995).
- 1996: Engineering evaluation of system condition, load, and capacity (Brown, 1996).
- 1999: Rehabilitation of the upper production well, CW-1.
- 2000: Repair of the injection well piping due to a corrosion failure.
- 2000: Addition of new circulation pump, CP-2.
- 2000-2001: Extension of district heating system to serve the Klamath Falls wastewater treatment plant and 100,000 sq. ft. greenhouse facility.
- 2001: Michigan Street system abandoned.
- 2003: Evaluation of capacity and improvements needed to support an expansion of the greenhouses (now at 4.0 acres). Partially funded by NREL.
- 2003-2004: System improvements including new heat exchangers, new automatic controls, improved pipe tunnel and vault ventilation, replacement of pipeline expansion joints, rehabilitation of the lower production well, CW-2. Partially funded by NREL.
- 2006: Addition of circulation pump, CP-3, to match the pump added in 2000.
- 2006: Expansion of the district heating system mains and development of a new sidewalk snowmelt system to serve the Timbermill Shores development on a former mill site.

The Klamath Falls district heating system is beginning to be financially viable and self-sustaining after 25 years of operation. The path to that point has been long and difficult, but thanks to the long-term commitment of the people of Klamath Falls, a difficult beginning has been turned into a successful system.

LESSONS LEARNED

The geothermal district heating system design and materials selection was based on a preliminary design study in 1979 by LLC Geothermal Consultants, Klamath Falls, OR. (Lund, et al., 1979). The engineer of record, Balzheiser/Hubbard & Associates, implemented the preliminary design recommendations with minor modifications.



Photo 1: Drilling of CW-1 well (Geo-Heat Center)

Production Wells

Production well pumps are vertical line shaft pumps, oil lubricated, with variable-speed drives. The well pumps as originally designed were rated for 500 gpm each, and powered by 50 hp motors.

The well pump for CW-1 was removed and rehabilitated in 1999 and CW-2 was rehabilitated in 2004. Inspection of the pumps showed significant corrosion of the steel column pipe at and above the water level, but no corrosion significantly below the water level. The corroded column pipe was replaced and the rest of the column pipe was reused. The pump bowls, line shaft, bearings, and shaft tube were in good condition and were reused.



Photo 2: Well Pump (Brown)

The original 50 hp motors and Nelson fluid drive were removed and replaced with an adjustable frequency drive and a 75 hp motor. The adjustable frequency drive and larger motor give the capability to over-speed the pump by about 20% from the nominal design speed of 1750 rpm to 2100 rpm. The increased pump speed can provide about a 20% increase in pumping.

The original system used Nelson fluid drives for variable speed operation. City water which was used to cool the drive was discharged down the well. That cooling water kept the outside of the column pipe wet and introduced oxygen into the well, promoting corrosion. Replacement of the Nelson drives with adjustable frequency drives allowed elimination of the cooling water flow and the resulting corrosion.

Geothermal Transmission Pipeline

Geothermal flow from the production wells is conveyed to the heat exchanger building through an 8-inch steel pipeline, about 4400 feet long. The pipe is insulated with polyurethane foam insulation, protected by a fiber-wound FRP jacket. About one-third of the pipeline is direct-buried; the rest is enclosed in a concrete pipe tunnel.



Photo 3: Production Pipeline and Tunnel Construction (Babcock)

Pipe expansion in the direct-buried section is accommodated by expansion joints with stainless steel bellows, located in expansion joint vaults. Pipe expansion in the tunnel is accommodated by expansion joints and pipe roller-guides.

The interior of the pipe is in excellent condition with minimal corrosion. The exterior of the pipe has suffered varying degrees of corrosion damage, particularly at fittings, expan-

sion joints, and pipe anchors where the steel has been exposed to moisture. The expansion joints and pipe tunnel were intended to protect the pipe by providing a dry environment. However, the atmosphere in the vaults and tunnel was extremely humid because of inadequate ventilation and infrequent maintenance of the vault drains. Moisture would condense on the vault and tunnel ceilings and then rain down on the pipe. There is evidence of past flooding, resulting in direct contact of water and sediment with the pipe.

The city installed two six-inch vent pipes to each expansion joint vault, with one pipe connected high in the vault and the other low. The vent pipes provide thermal and wind-driven ventilation of the vaults, which reduce the high humidity and condensation. Tunnel ventilation has been improved by installing a blower at the heat exchanger building to force air into the tunnel and a larger relief vent at the far end of the tunnel.

The city has had to repair two corrosion failures in the direct-buried portion of the pipeline. It appears that the FRP jacket is beginning to fail and allow soil moisture to contact the pipe. The City plans to replace the steel pipeline with pre-insulated ductile iron pipe as funds allow.

District Heating Distribution

The district heating distribution piping is a closed loop system with both supply and return pipelines. Almost half of the original system length was 10-inch, pre-insulated steel pipe. The rest of the piping, 8-inch and smaller, was key-lock fiberglass pipe.

The fiberglass pipe joints failed after the first heating season, possibly due to defective epoxy on the factory-glued joints, and were entirely replaced with pre-insulated ductile iron pipe. Where the ductile iron pipe has been inspected, it remains in good shape after 15 years of service.

The steel portion of the pipeline was protected by the insulation system and cathodic protection anodes, which have not been checked since construction. There have been recent corrosion failures in the steel pipelines; likely caused by failure of the FRP jacket coupled with diminished cathodic protection. The city plans to replace the pipe with pre-insulated ductile iron as funds allow.

Some customer service connections were installed using unprotected steel piping. Those connections have tended to fail after about ten years. Improved corrosion protection is being used on new and repaired connections.

District Heating System Controls

The control system was originally designed to maintain the district heating supply temperature at a constant 180°F by controlling geothermal production and the flow through the heat exchanger. On decreasing temperature of the supply water, the system was intended to increase the geothermal production by increasing the well pump speed and automatically starting the second well pump if needed. On

increasing temperature of the supply water, the system would reduce production, then modulate a three-way valve to bypass district heating water flow around the heat exchanger.

The geothermal water temperature is above boiling temperature at the project elevation, so a backpressure valve and control was designed to maintain enough pressure on the geothermal production piping to prevent flashing to steam in the system.

The original pneumatic control system was not capable of meeting the design control objectives. The fully automatic temperature control operation resulted in serious oscillations of well pump speed and starting/stopping. The resolution was to operate the well pumps manually, and limit the automatic temperature control to the three-way valve. The backpressure control was also unstable, partially due to inappropriate valve selection.

The control system was upgraded in 2003 to modern digital controls, using Allen Bradley programmable logic controls (PLC). The telephone telemetry link to the production wells was replaced with spread-spectrum radio telemetry. The control system is fully integrated with the city control system for water and wastewater system operation.

The original temperature control and backpressure control concepts were retained with the new controls. The increased power and tuning capability of the modern controls have largely been able to tame the unstable control loops.

Back-pressure control is a difficult control service, with the valve required to operate over a wide flow range, controlling hot fluids that can flash to steam or cause cavitation on the downstream side of the valve. There remains some instability in the backpressure control even with the new control system and a new control valve. More stable operation can likely be achieved by reprogramming the controls to operate the valve for temperature control, and control the well pumps to maintain a pressure set-point. On decreasing temperature the controls would open the valve, resulting in increased flow and reduced pressure. The controls would then increase the pump speed to compensate.

CAPACITY AND LOAD

The capacity of a closed-loop district heating system is fundamentally different than the capacity of a potable water system. The purpose of a water system is to deliver water, which is consumed in some way and not returned to the water system. What the customer does with the water is not a major consideration; the water system is sized for the capacity to deliver given design flow.

A district heating system is designed to deliver heating energy. The water flow is merely a means to convey the energy. The capacity to deliver heat is limited both by the flow capacity of the system and what the customer does with the heating water before sending it back. The capacity

of the system is thus very much constrained by the action of the customers. The amount of heat delivered by the water depends on both the flow rate and the temperature change of the water. This can be expressed by the equation:

$$ENERGY (BTU/HR) = FLOW (GPM) \times \Delta T (^{\circ}F) \times 500$$

Flow is essentially fixed by the hardware selected in the design: the pumps, pipes, control valves, heat exchangers, production wells, and injection well. Any significant increase in the flow requires larger equipment and increased power to operate.

Temperature change of the heating water (delta-T) is equally important to the delivery of heat. The delta-T is affected by physical constraints such as the temperature of the heat source, the temperature requirements of the heat load, and the sizing of the heat transfer device. The main cause of low delta-T is failure to properly control heating water flow, with the consequence of reduced thermal capacity and higher than necessary pumping costs.

The Klamath Falls geothermal district heating system was designed with a thermal capacity of 20×10^6 Btu/hr (5.9 MWt), based on 1,000 gpm of loop flow, 1,000 gpm of geothermal flow, and a design delta-T of 40°F. The load on the district heating system is approaching the original design thermal capacity. According to the system data log, the peak load for the 2005-2006 heating season was about 14.9×10^6 Btu/hr, on December 1, 2005 at 7:58 AM, at an outside air temperature of 10°F. Geothermal flow was 764 gpm. Loop flow was 819 gpm.

In another sense, the system was operating at near capacity in 1993 when the loop flow was about 900 gpm at a maximum 10°F delta-T, or in 1996 at a loop flow of 850 gpm and 16°F system delta-T. The ability to add customers to the system and thus increase revenue has primarily been possible because of improved flow control at customer connections, increasing the delta-T and freeing up flow capacity.

Recent improvements were intended to increase the nominal system capacity to about 36×10^6 Btu/hr (8.5 MWt), based on 1,200 gpm pumping capacity and 60°F delta-T. Some of that increased capacity is due to new heat exchangers and increased circulation pump capacity. However, most of the capacity increase is dependant on improvement in system delta-T. Proposed measures to achieve improved delta-T include:

- Continued improvement of flow control at existing customer connections
- Cascading flow from higher temperature users to lower temperature users. For example, operating snowmelt systems off the district heating loop return line rather than supply line.
- Designing new connections to the system for a higher delta-T of 60°F.

ECONOMICS

Original Projections

The geothermal district heating system was designed to initially serve 14 government buildings with planned expansion to serve additional buildings on 11 commercial blocks along the route, then the entire 54-block downtown commercial district. The anticipated system heating loads for the planned construction phases were: (Lienau, 1981)

Phase	Description	Peak heat load Btu/hr
I	14 Government Buildings	21 x 10 ⁶
II	11 Commercial Blocks	34.8 x 10 ⁶
III	54 Commercial Blocks	143 x 10 ⁶

The system feasibility study was conducted during the late 1970s energy crisis, when there was sharp run-up in the cost of natural gas and other energy. Figure 2 shows a 20-year life-cycle cost comparison of the proposed project on a unit energy basis. (Lienau, 1981) Key assumptions included:

- System peak load: 34.8 x 10⁶ Btu/hr (Phase II)
- Annual energy use: 60 x 10⁹ Btu
- Capital cost: \$3,753,259 at 8%
- O&M 6.2% of capital; inflated at 7%/year
- Natural gas inflation: 14.6% to 17.6% /year

The analysis calculated that the cost of the geothermal energy would match natural gas at about year five, at a cost of about \$7.00 per 10⁶ Btu, and simple payback would occur at ten years.

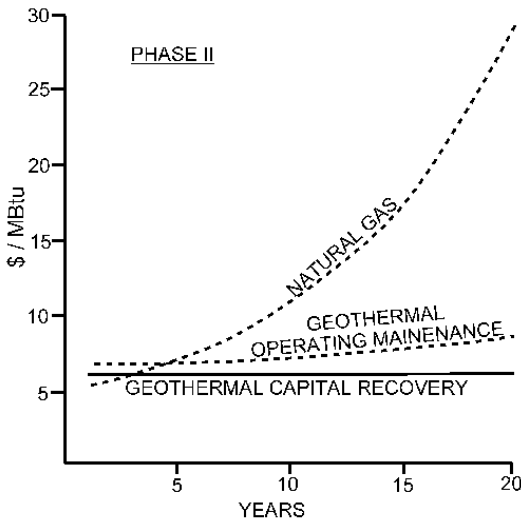

Figure 2. Phase II Unit Energy Cost Comparison (Lineau, 1981)

Initial Operation

Phase I was funded and constructed as a demonstration project, with most of the cost covered by grants. On that basis, the expectation was that the economics would be better than the Phase II analysis. Unfortunately, the system did not meet those expectations.

The first hurdle was concerns by home owners about the impact of operation of the geothermal system on their private wells. Klamath Falls has hundreds of private homes heated by private geothermal wells. The concern was that the city system would lower the water level and/or reduce geothermal temperatures, negatively affecting the private wells. The home owners initiated a city ordinance that effectively prohibited operation of the newly constructed district heating system. That problem was resolved by extensive aquifer testing, including full operational testing that showed no negative impact. However, start-up of the district heating system was delayed by three years to November 1984.

The next hurdle was failure of the fiberglass distribution system piping after only one heating season. The city was faced with the question: do they rebuild, or shut the system down. The decision was to borrow the needed funds and rebuild the distribution system. The system was restarted in January 1991.

Meanwhile, the cost of natural gas dropped from a high of \$0.627/therm (10⁵ Btu) in October 1982, to a low of \$0.378/therm in December 1991. See Figure 3. That compares to a projected cost of about \$1.10/therm at year ten in the original economic analysis. The total heating revenue for 1991 was about \$23,800, which was well below the cost of system operation.

The city was again faced with a choice: shut the system down, or subsidize operation while attempting to grow the connected load and revenue. The city began a marketing push in 1992, and over the following 13 years the system load has been increased to near the original Phase I design capacity. The cost of conventional energy has also increased, making the renewable geothermal energy more valuable.

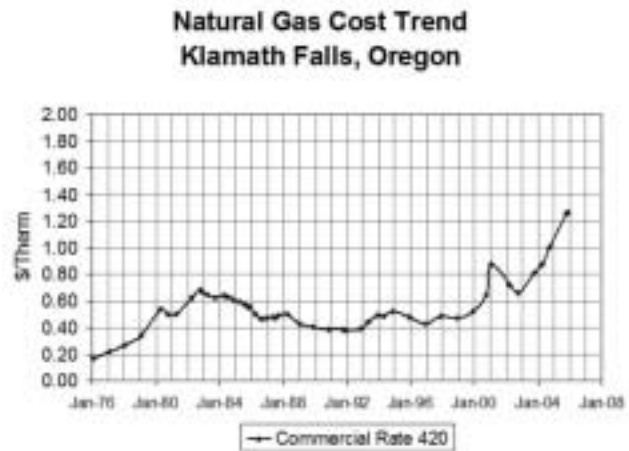

Figure 3. Local Natural Gas Cost Trend.

Current Status

The geothermal district heating system provides a significant financial impact on the local community. For 2005, the metered geothermal energy sales was about 26.1x10⁹ Btu, and un-metered building energy use was about 5.3x10⁹ Btu, for a total of 31.4x10⁹ Btu. Currently, the commercial natural

gas rate is \$1.26353 per therm, or assuming a seasonal conversion efficiency of 67%, about \$18.8/10⁶ Btu. The direct economic value of using geothermal energy from the district heating system rather than fossil fuels was about \$589,000.

Economic value is also realized indirectly by the contribution of the geothermal system to economic growth and downtown revitalization. The availability of geothermal energy was a major factor in the decision of the IFA Nurseries greenhouses to locate in Klamath Falls. The geothermal energy allows IFA to control their energy costs. In return they contribute jobs to the community and tree seedlings for local reforestation efforts. Geothermally heated sidewalk snowmelt systems are a very visible and popular feature of the downtown redevelopment project, which has helped turn around a formerly declining downtown area.



Photo 4: Geothermally Heated Sidewalk Snowmelt (Geo-Heat Center)

The economic value of the geothermal district heating system to the community is clearly significant. The other question is whether the revenue to the system operator is adequate to cover costs. The city cannot charge the full value of conventional energy, or there would be no incentive for customers to connect.

The city metered geothermal rate is set at 80% of the current commercial natural gas rate, with rate increases limited to no more than 10% per year. The current standard rate is \$8.828/10⁶ Btu. A significant portion of the load is still billed at long-term flat rates negotiated several years ago, of \$5.40/10⁶ Btu or \$5.60/10⁶ Btu. The 2004-2005 heating season average for metered accounts was \$6.15/10⁶ Btu. There are still several unmetered buildings that will be metered within the next couple years.

Total system revenue for the 2004-2005 heating season was \$170,012. Direct operating expenses for the same period were \$47,403. Additional deferred maintenance costs that should be included in the annual costs include about \$15,000 annually for heat exchanger plate cleaning and regasketing, and about \$70,000 annual financing costs for about \$800,000 in needed pipeline repair and upsizing. The city should also be funding a maintenance reserve and greater staff time for

managing system operation, system growth, and customer connection delta-T control.

After 25 years the system operation is at or near operational break-even. The revenue should continue to increase over the next few years as more customers are added and existing unmetered customers are switched to metered service. The increased revenue should help with funding of other operational needs.

In retrospect, the original economic analysis was not too bad; there was just a 20-year pause in the growth of energy costs, and a 15 year delay in geothermal system expansion. The people of Klamath Falls are to be commended for their perseverance through the lean times.

ACKNOWLEDGMENTS

This paper was partially based on work funded by the National Renewable Energy Lab, Golden Colorado, and the City of Klamath Falls. Opinions expressed in this paper are those of the author. Thanks to John Lund, the OIT Geo-Heat Center, and Brent Babcock (Balzheiser/Hubbard project manager), for their perspective on the original system design and construction.

REFERENCES

- Brown, B., 1995. "Klamath Falls Downtown Redevelopment Geothermal Sidewalk Snowmelt", Geo-Heat Center Quarterly Bulletin, Vol. 16, No. 4., p. 23-26.
- Brown, B., 1996. "Klamath Falls Downtown Geothermal District Heating System Evaluation", Geo-Heat Center Quarterly Bulletin, Vol. 17, No. 3., p.16-23.
- Lienau, P.; G. Culver and J. Lund, 1977. "Klamath County Geo-Heating District Feasibility Study" prepared for Klamath County Commissioners, Geo-Heat Center, Klamath Falls, OR.
- Lienau, P., 1981, "Design of the Klamath Falls Geothermal District Heating Network", ASHRAE Transactions, Vol. 87, p. 2, Atlanta, GA
- Lienau, P.; G. Culver and J. Lund, 1989. "Klamath Falls Geothermal Field, Oregon, Case History of Assessment, Development and Utilization", Presented at Geothermal Resources Council 1989 Annual Meeting, Santa Rosa, CA.
- Lienau, P. and K. Rafferty, 1991. "Geothermal District Heating System: City of Klamath Falls", Geo-Heat Center Quarterly Bulletin, Vol. 13, No. 4., p. 8-20.
- Lund, J. W.; P. J. Lienau; G. Culver and C. V. Higbee, 1979. "Klamath Falls Geothermal Heating District" Report to City of Klamath Falls, LLC Geothermal Consultants, Klamath Falls, OR.
- Rafferty, K., 1993. "Marketing the Klamath Falls Geothermal District Heating System", Geo-Heat Center Quarterly Bulletin, Vol. 15, No. 1., p. 4-6.

FROM CREAMERY TO BREWERY WITH GEOTHERMAL ENERGY: KLAMATH BASIN BREWING COMPANY

Andrew Chiasson, Geo-Heat Center



INTRODUCTION

The Klamath Basin Brewing Company, located in Klamath Falls, Oregon, is the only known beer brewing company in the world that uses geothermal energy in their brewing process. The brewery opened in 2005 after renovating the historic Crater Lake Creamery Building, built in 1935. The building is now known as “The Creamery Brewpub and Grill”. The brewery currently brews about 10 different beers.

THE GEOTHERMAL RESOURCE AND DISTRIBUTION SYSTEM

The City of Klamath Falls is located in a Known Geothermal Resource Area (KGRA) that has been used to heat homes, businesses, schools, and institutions since the early 1900s. The Creamery Brewpub and Grill is part of the Klamath Falls district geothermal heating system, which was originally constructed in 1981 to extend the benefits of geothermal heating to downtown Klamath Falls. This year (2006) marks the 25th anniversary of the district heating system, and after some difficult times in its development, the system now provides heat to 24 buildings totaling about 400,000 ft² (37,200 m²), 150,000 ft² (14,000 m²) of greenhouse space, 105,000 ft² (9,750 m²) of sidewalk snow-melting area, and also provides process heat to the Klamath Falls wastewater treatment plant (WWTP).

The history and design of the Klamath Falls geothermal district heating system has been recently summarized by Brown (2006). The system is served by two geothermal production wells located about 1 mile (1.6 km) from the downtown area. Well #CW-1 is 367 ft (112 m) deep with a groundwater temperature of 226°F (108°C) and well #CW-2 is 900

ft (274 m) deep with a groundwater temperature of 216°F (102°C). Production well pumps, which are the vertical line shaft type each rated at 500 gpm (31.5 L/s) pumping capacity with a 50 hp (37 kW) motor, convey geothermal water through a transmission pipeline to a central heat exchange building. The transmission pipeline is 8-inch (203 mm) steel with polyurethane foam insulation protected by a fiber-wound FRP jacket. The pipeline is about 4,400 ft (1,340 m) long, with about one-third of the line being direct-buried and the remainder enclosed in a concrete tunnel.

At the heat exchange building, the geothermal water transfers heat to the closed downtown circulating heating loop via large stainless steel plate-type heat exchangers. The geothermal water is then injected back into the aquifer via a 1,200 ft (365 m) deep injection well adjacent to the heat exchange building. Hot water is provided to the downtown customers at approximately 180°F (82°C). Variable speed drives on well pumps and circulating pumps in the closed heating loop help the system to maintain the design supply temperature.

THE BREWERY GEOTHERMAL SYSTEM

The Creamery Brewpub and Grill uses geothermal energy from the Klamath Falls geothermal district heating system for all its heating purposes. Uses of geothermal energy include space heating of approximately 11,000 ft² (1,022 m²) of restaurant/pub space, snow-melting of about 1,000 ft² (93 m²) of sidewalks, and generation of hot water for the brewing process.

THE BREWING PROCESS

The brewing process is shown schematically in Figure 1. The process starts with malted barley stored in a silo outside

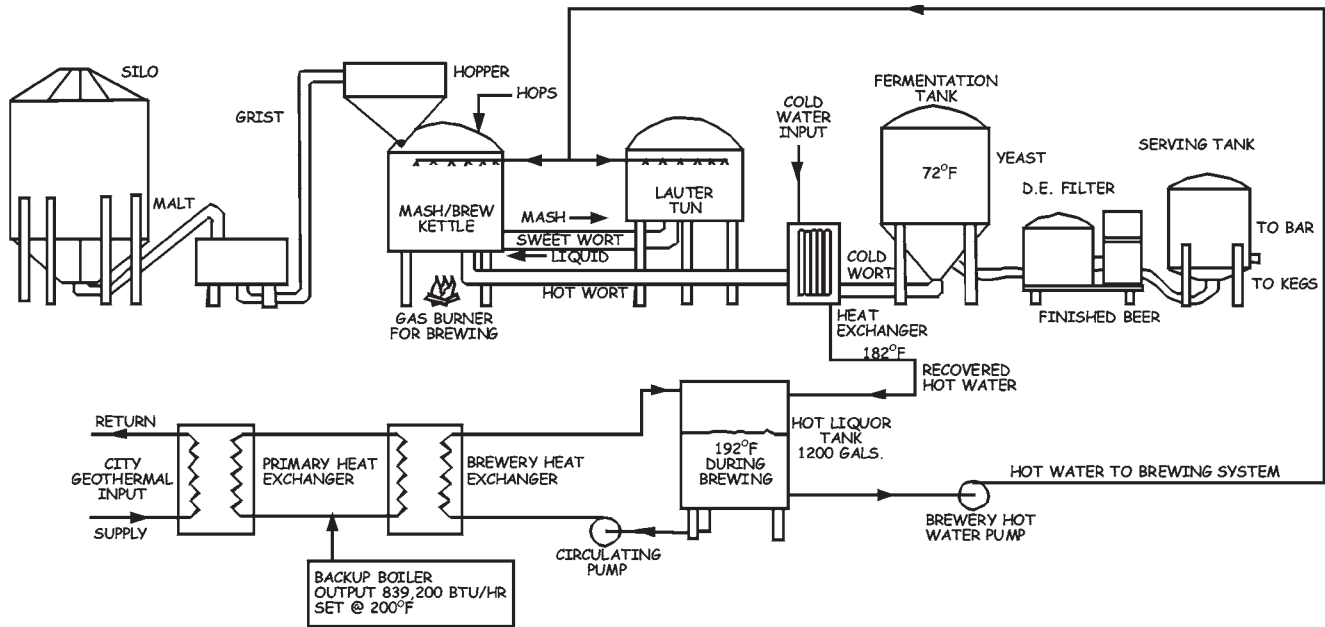

Figure 1. Brewing process schematic.

the building (Figure 2). The blend of malts required for a particular recipe is cracked in a roller mill. The milled malt or “grist” is transported by an auger to the grist hopper above the brewhouse.

The grist is mixed with hot water generated from the geothermal source in the mash tank (Figure 3), which starts the process of “mashing”. As shown in Figure 3, the hot water provided by the City geothermal system exchanges heat with a heating loop, which includes a backup/supplemental boiler. The heat exchanger between the primary geothermal water and secondary heating loop is shown in Figure 4.



Figure 2. Photograph of the malted barley silo.

This secondary loop provides heat through another plate-type heat exchanger to the pure water stream used in the brewing process. The desirable temperature of the mash is

about 154°F (68°C), and depending on the temperature of the grist (which enters the building near ambient outdoor temperatures), hot water up to 192°F (89°C) must be supplied. After a few hours, mashing converts starches in the malt to sugars, and then the mash and the sweet liquid called “wort” are transferred to another tank called the “lauter tun”.

Once the mash and wort are transferred to the “lauter tun”, the wort is pumped back to the mash tank which now becomes the brew kettle. During this step, the “lautering” process is started, which is done by rinsing the mash with clean hot water at a temperature of about 172°F (78°C), generated from the geothermal source. The temperature of the water will shut down the conversion process of starch to sugar so that the wort will not become astringent tasting.

Once the brew kettle is full, the wort is brought to a boil for about two hours using a gas burner. Bittering hops are added at the beginning of the boil, while hops used for aroma and flavor are added toward the end. After the boiling process, the wort is “whirlpooled”, where the centrifugal force separates the hops from the wort and helps clarify the wort.

The wort is then cooled as it passes through a heat exchanger on its way to temperature-controlled fermentation tanks kept at 72°F (22°C).

The initially cold water on the cold side of the heat exchanger is recovered at about 182°F (83°C) and is pumped to the hot liquor storage tank. During the transfer of the wort, yeast is added which ingests the sugars to produce alcohol and carbon dioxide. Many different strains of yeast are used to give many different flavors of the finished beer. Fermentation takes 3 to 4 days for ales and 1 to 2 months for lagers.

The Klamath Basin Brewing Company does not filter their beer, as it is believed that using “fines” to help clarify the



Figure 3. Photograph of the mash tank/brew kettle.

beer results in a more full-flavored beer. The finished beer is carbonated and stored in serving tanks in a walk-in cooler, where it is either kegged or served to customers.

ENERGY CONSUMPTION AND OPERATING COST

City metering of geothermal energy usage by the Creamery Brewpub and Grill has just begun in March 2006, so documented geothermal energy use history is limited. During March 2006 when a significant amount of space heating and snow-melting were required, the Creamery Brewpub and Grill used about 1,700 therms (179 GJ) of geothermal energy, which cost about \$1,360. The avoided cost of natural gas at 80% efficiency and \$1.20/therm would be about \$2,550. Therefore, the Creamery Brewpub and Grill saved about \$1,190 during the month of March 2006 with geothermal energy.

During the month of June 2006 when most of the geothermal energy would be used for beer brewing, the Creamery Brewpub and Grill used about 430 therms (45 GJ) of geothermal energy, which cost about \$344. The avoided cost of natural gas at 80% efficiency and \$1.20/therm would be about \$645.



Figure 4. Photograph of the heat exchanger between the City geothermal district heating system and the brewery secondary heating loop.

Therefore, the Creamery Brewpub and Grill saved about \$300 during the month of June 2006, with geothermal energy. It should be noted however, that the geothermal system was shut down sometime in June 2006, so these values may not be representative of a full month's energy usage.

ACKNOWLEDGEMENTS

The Geo-Heat Center wishes to thank the owners of the Klamath Basin Brewing Company, D. Azevedo & L. Clement, for providing the information for this case study, and D. Beach of Stanford University for the photographs.

REFERENCES

Brown, B. 2006. "Klamath Falls Geothermal District Heating System at 25 years", *Geothermal Resources Council Transactions Vol. 30*, pg. 185-190.

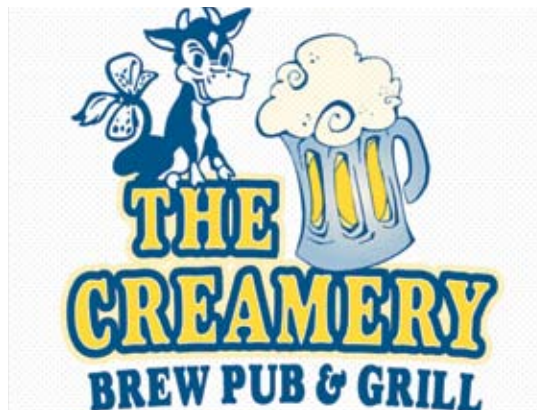

NEW GREENHOUSES IN KLAMATH FALLS

John W. Lund
Geo-Heat Center

A state-of-the-art 50,000-sq ft greenhouse, heated by geothermal energy, was recently put into operation in Klamath Falls, Oregon (Figure 1). The greenhouse, which uses technology that has long helped Canada dominate the market for tree seedlings is operated by IFA Nurseries, Inc., based in Canby, Oregon. The facility can raise about two million seedlings of ponderosa pine, Douglas fir, hemlock and other species, depending upon the demand of customers. Eventually, they plan to have four greenhouses in operation, producing about eight million seedlings a year. A second greenhouse is currently under construction and will be ready for use this fall (Figure 2).



Figure 1. *50,000-sq ft greenhouse currently in operation.*



Figure 2. *The second greenhouse under construction.*

The operation was located in Klamath Falls to take advantage of the geothermal heat available from the city's district heating system. To attract the business, the city of Klamath Falls extended their hot water pipeline from the downtown to the greenhouse, located on the edge of town near the South 6th street overpass and city maintenance yard. The heated water is provided from the supply side of the district heating system (see Brown, 1999) at 180°F, and the spent water is then piped to the return side of the district heating loop. A plate heat exchanger (Figure 3) transfers the heat to a secondary loop using a water-glycol mixture (Figure 4). This loop then provides heat to a series of under-bench fan coils and hot air plastic distribution tubes (Figure 5). IFA pays the city for the heat at a rate somewhat less than the corresponding natural gas rate, which does not fluctuate with the market.



Figure 3. *The main plate heat exchanger.*

The seedlings, growing in long rows of Styrofoam containers (Figure 6), are watered by long wands that slide across the ceiling. A computer controls the heat supply, watering, lights and ventilation through opening and closing perimeter curtains and vents in the roof. Controlled lighting and uniform temperatures help the growth rate, as what normally would take a year to grow in normal light, grows in six months in this controlled environment. In addition, seedlings grown indoors in containers usually survive transplanting better than those from outdoor nurseries; where, they are uprooted for shipping. Typically, about 98 percent of the seedlings grown in the nursery's Styrofoam containers survive transplant. The customers include Boise, Sierra Pacific and Roseburg Forest Products, for planting in California, Oregon, Nevada and Idaho.



Figure 4. *Secondary distribution system being installed for the new greenhouse.*

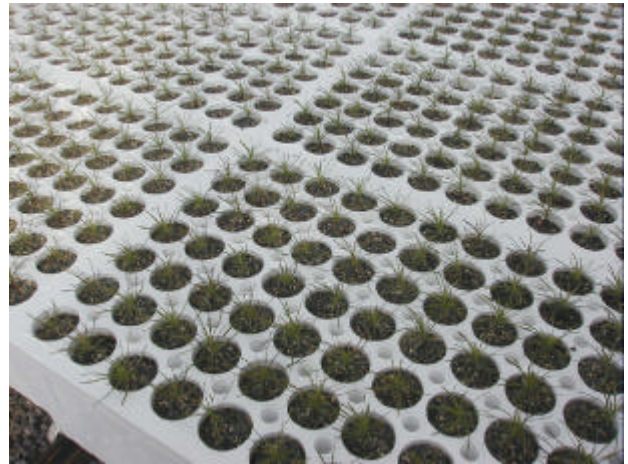

Figure 6. *Tree seedlings in Styrofoam containers*



Figure 5. *Under-bench heating system.*

ACKNOWLEDGMENTS

Material for this article is based on personal interviews with the manager Charlie Patton, and from an article in the *Oregonian* newspaper (Milstein, 2002).

REFERENCES

- Brown, Brian, 1999. "Klamath Falls Geothermal District Heating System," *Geo-Heat Center Quarterly Bulletin*, Vol. 20, No. 1 (March), Klamath Falls, OR, pp. 5-9.
- Milstein, Michael, 2002. "Seedlings Get a Jump-Start in High-Tech Greenhouse," *Oregonian*, Wednesday, May 22, Portland, OR, p. B1-2.

NEW SNOW MELT PROJECTS IN KLAMATH FALLS, OR

Tonya L. Boyd
Geo-Heat Center

INTRODUCTION

A \$1.3-million dollar project consisting of two bridge replacements was a joint effort by the Oregon Department of Transportation (ODOT) and the city of Klamath Falls. The two bridges replaced are on Eberlien Avenue and Wall Street, which spans over the A canal that furnishes irrigation water to the farmers south of town. The replacement of the Wall Street Bridge and approach road incorporated a snow melt system designed by Meredith Mercer of ODOT using geothermal for the street, bridge deck and sidewalks. Due to the location of the A canal, the Wall Street approach road has about a 13.25% grade to the bridge and can be very hazardous during the winter season. The cost of the snow melting system for the Wall Street Bridge was \$170,000 for the hydronic tubing placement, and \$36,000 for the mechanical equipment and plumbing. This is the second bridge project in Klamath Falls, which will utilize geothermal for snow melting (Lund, 1999). The geothermal heat will be provided by the city of Klamath Falls District Heating System. The project was completed in June 2003.

Oregon Institute of Technology also placing a new snow melting system on an existing stairway by the College Union building and a snow melt system in a new handicap ramp on the north side of the College Union building.

WALL STREET BRIDGE AND STREET PROJECT

The Wall Street Bridge and Street Project has approximately 10,330 ft² (960 m²) of snow melting surface (Figure 1). The bridge deck and sidewalks snow melt area are 88.6 ft (27 m) by 42 ft (12.8 m) for a total of 3720 ft² (345.6 m²) of surface area. The approach road and sidewalk snow melt area are 157.5 ft (48 m) by 42 ft (12.8 m) for a total of 6613 ft² (614.4 m²) with an estimated heat output of 60 Btu/ft²/hr (189 W/m²).

A separate heat exchanger installed in the city's heat exchanger building will be used for the Wall Street Project, which will tap into the geothermal return water of the district heating system before it is injected into the ground. The heat exchanger specifications are 316 stainless steel plates with standard nitrile gaskets providing approximately 600,000 Btu/hr (174 kW) and designed for 150 psi (1,030 kPa) operating pressure (Figure 2). The heat exchanger will transfer heat to a 35% propylene glycol solution, which will be circulated in a closed loop to the approach road and bridge. The geothermal water side of the heat exchanger will enter at about 150°F (66 °C) and leave at 110°F (43 °C). The glycol solution side of the heat exchanger will enter at about 100°F (38 °C) and leave at about 130°F (54 °C). The geothermal loop side of the heat exchanger has a 1/3-hp (250 W) vertical

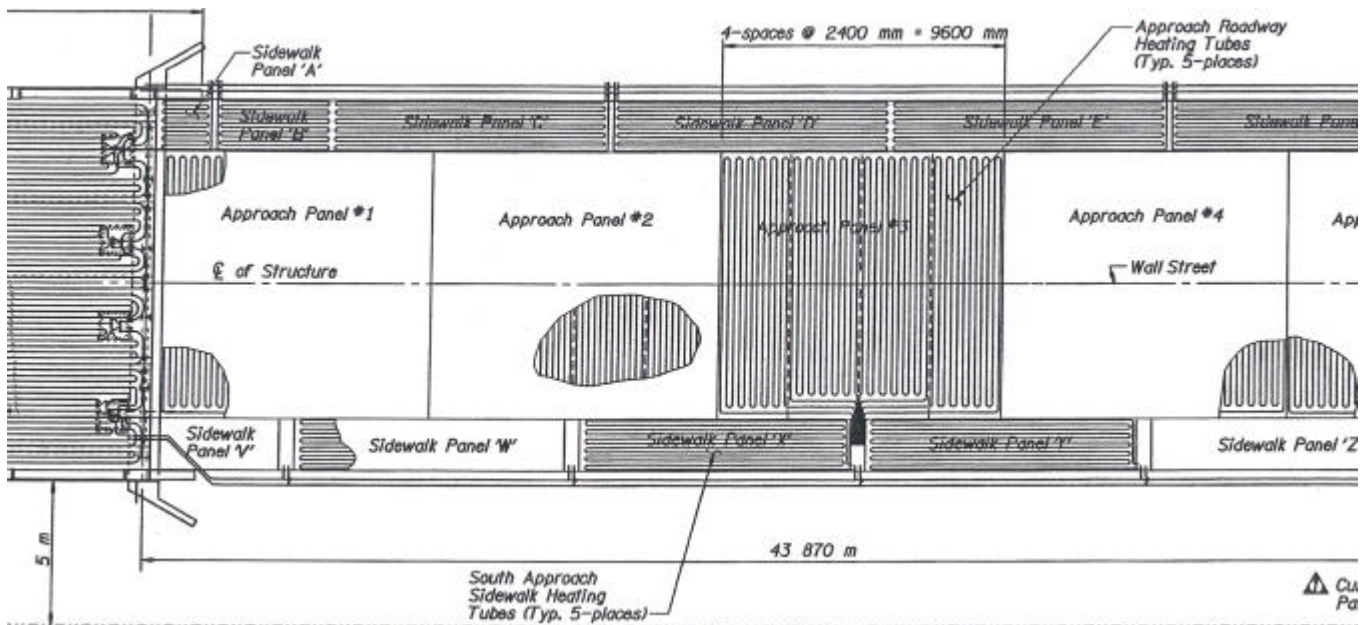

Figure 1. Portion of the Wall Street Project (ODOT, 2003)

in-line centrifugal pump installed with a flow rate of 40 gpm (2.5 L/s). The bridge loop side of the heat exchanger has a 1/2-hp (375 W) vertical in-line centrifugal pump installed in that side to circulate the solution with a flow of 45 gpm (2.8 L/s). This loop has more capacity installed than will be needed at this time. The system was designed for possible snow melt systems to be added in the future. An expansion tank is also connected to the heat exchanger, which has a minimum volume of 55 gal (210 L) and a minimum 22 gal (85 L) acceptance capacity. The system will run continuously during the winter season.



Figure 2. *Snow melt heat exchanger in the city's Heat Exchanger building.*

The approach road and bridge is about 1/2 of a mile (800 meters) from the heat exchanger building. The pipeline from the heat exchanger building to the approach road consists of a 4-in. (100 mm) high density polyethylene (HDPE) pipe when it leaves the building, then transitions into a 3-in. (75 mm) HDPE pipe at the approach road to the bridge.

The bridge project was completed in parts. The first part was removal of the existing bridge deck, then building of the new bridge deck. The bridge loop system was then tied into the bridge reinforcing steel. After the concrete was placed on the bridge deck and curing completed, they worked on the bridge sidewalks and loop system. Concrete was then placed on that part of the bridge and allowed to cure. They then worked on the bridge railing. While the bridge railing was being worked on, they removed the existing approach road material down to the sub-base. The road was then prepared and reinforcing of the road was placed. The loops for the approach road were tied into the reinforcing. The concrete was then placed and allowed to cure. The formworks for the sidewalks were completed, and the concrete placed and allowed to cure.

The mains control valve box (Figure 3), located on the southeast corner of the approach road, is where the main line is split into two lines. One line goes over to the north sidewalk with a 1-in (25-mm) supply and return line for the north sidewalks, and the other goes up the south side with a 3-in (75-mm) supply and return line for the manifolds located on the south side and the bridge deck manifolds.



Figure 3. *Details of the main control valve box.*

The glycol solution will be pumped through the tubing in the bridge deck and approach road. The tubing placed was Wirsbo 5/8-in (16 mm) ID hePEX (a cross-linked polyethylene), which was used on the other bridge deck (Lund, 1999). The loop system consists of about three miles (4,700 m) of tubing. The approach road has five approach panels consisting of four loops for a total of 20 loops. The bridge deck has 11 loops. The sidewalks of the bridge has two loops each. The approach road sidewalks has 11 separate loops, six on the north side and five of the south side.

The loop system for the bridge was placed longitudinally on the bridge deck with the loops ending on the approach roadside of the bridge (Figure 4). The loop systems for the bridge and approach road sidewalks was placed longitudinally (Figure 5). The approach road loop system was placed latitudinally with the loops ending on the south side of the road (Figure 6). All the loops are attached to reinforcing steel by wire at approximately eight inches (200 mm) on center. The ends of the loop systems for the bridge goes through the bridge deck. A protective sheath was placed around the tubing where the loops pass through the bridge deck.

There are a total of 12 manifold boxes used on this project. The bridge and bridge sidewalks has four manifold boxes placed underneath the east side of the bridge deck between the plate girders (Figures 7 and 8). The two manifold boxes nearest to the edge of the bridge has two 2-port supply and two 2-port return manifolds and the two manifold boxes in the center of the bridge has either 4-port supply and a 3-port return or the other way around (Figure 9). The middle loop down the centerline of the bridge has a supply loop on one manifold and a return loop on the other manifold.

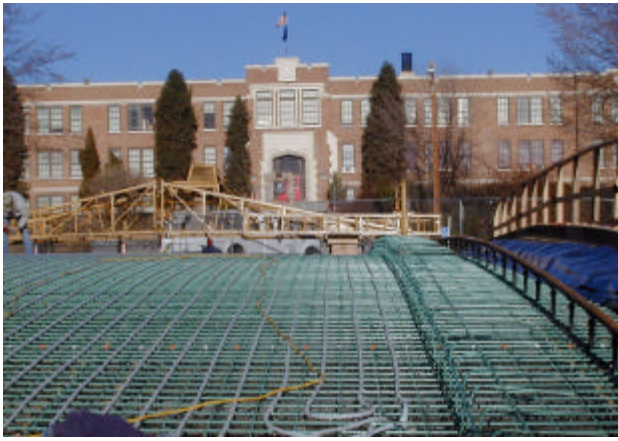

Figure 4. Bridge decking loops attached to the reinforcing steel.



Figure 7. Manifold under the bridge deck before they are placed in boxes.



Figure 5. Bridge sidewalk loops.



Figure 8. Manifold boxes under the bridge.



Figure 6. The approach road loops placed latitudinally.

The north sidewalks consists of six loops have three manifold boxes each with a 2-port supply and 2-port return manifold. The south sidewalks (five loops) and the

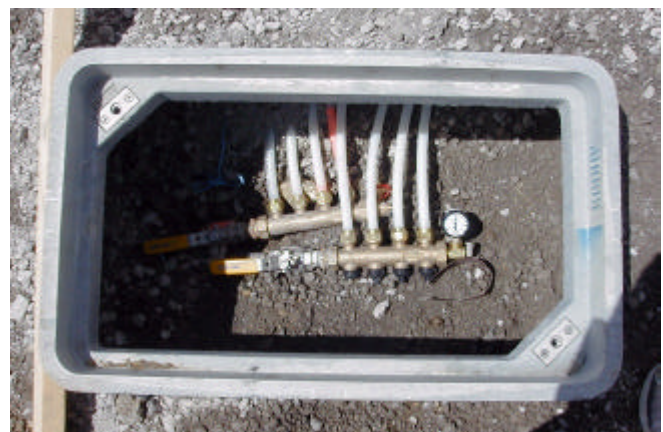

Figure 9. Detail of a manifold box for the south sidewalk.

approach road utilize five manifold boxes each with a 2-port and a 4-port supply, and a 2-port and a 4-port return manifold. The 2-port are for the sidewalk loops and the 4-port being for the road loop.

All the loop systems were pressure tested using air to check for leaks in the loops. The loops were continuously pressurized with 51 psi (350 kPa) air for at least 24 hours before concrete placement. The pressure was maintained during placement of the concrete and three days following placement.

The entire geothermal portion of the snow melting project was awarded at \$170,000, which figures out at \$16.45 per square foot. However, costs for state projects tend to be two to three times higher than private projects due to the requirements to pay prevailing wages and rigorous inspection standards. In addition, all plans are in metric, which may have posed a problem of conversion for local contractors.

To isolate the actual cost of purchasing and installing the pipes, the following items should be deducted. The supply line from the heat exchange building to the construction site, about 1 / 2 mile apart, is estimated to cost \$50,000 to \$80,000; the manifold boxes ran \$600 a piece and testing of the system cost \$10,000. Thus, the actual cost of the piping was around \$7 to \$10 per square foot. Non-state projects would probably run \$3.50 to \$4.00 per square foot.

OREGON INSTITUTE OF TECHNOLOGY PROJECT

The Oregon Institute of Technology (OIT) placed a snow melt system in an existing stairway by the College Union building. The project consisted of placing a slurring concrete mix over the existing stairway, then the tubing was tied to the formwork longitudinally with the stairway. They used a two-loop system for a total of 565 ft (172 m) of tubing placed, and the surface area that will be snow melted is 540 ft² (50 m²) (Figure 10) (Keiffer, 2003).

The other snow melt system was incorporated into a new handicap ramp placed on the north side of the College Union building. This system also used two loops for a total of 489 ft (149 m) of tubing and the surface area to be snow melted is 469 ft² (43.5 m²) (Keiffer, 2003).



Figure 10. Detail of the snow melt system for the stairs.

This brings the total amount of snow melting on the OIT campus to approx. 3,300 ft² (310 m²). Both systems are connected to the campus heating system via the campus tunnel system (Boyd, 1999).

ACKNOWLEDGMENTS

Special thanks to the Oregon Department of Transportation for providing plans and information especially, Steve Armstrong, Mike Schaaf, and Norm Cummings. Also, many thanks to Hack Hackman, Powley Plumbing, Inc.; Marlin Cunningham, City of Klamath Falls and Scott Keiffer, Oregon Institute of Technology, for answering questions about the projects.

REFERENCES

- Boyd, Tonya L., 1999. "The Oregon Institute of Technology Geothermal Heating System - Then and Now," Geo-Heat Center Quarterly Bulletin, Vol. 20, No. 1., pp. 10-13.
- Keiffer, Scott, 2003. Personal communication. Facilities Services, Oregon Institute of Technology.
- Lund, John W., 1999. "Reconstruction of the Pavement Geothermal Deicing System," Geo-Heat Center Quarterly Bulletin, Vol. 20, No. 1., pp. 14-17.
- Oregon Department of Transportation, 2003. "Grading, Structure and Paving "A" Canal Bridges (Klamath Falls) Section, Wall Street and Eberlein Avenue, Klamath County." Contract No. 12745.

"GONE FISHING" AQUACULTURE PROJECT KLAMATH FALLS, OREGON



Overview of the 72 15-ft x 100-ft fish ponds near Klamath Falls, OR.

LOCATION

The "Gone Fishing" aquaculture project is located about 10 miles south of Klamath Falls, Oregon, near Merrill in the Lower Klamath Valley adjacent to the Klamath Hills. The original ponds were constructed in 1984 and had limited use. The present facility, operated by Ron Barnes, started in 1990 using the effluent from a geothermal greenhouse operation on the Liskey Ranch on Lower Klamath Lake Road. In 1998, he purchased 80 acres of land just north of the greenhouses on the opposite side of the road. Today, the operation consists of 37 ponds located on the Liskey Ranch and 35 at the new location. The aquaculture ponds are used to raise 85 varieties of tropical fish (cichlids) that originated from Lake Malawi in East Africa's Great Rift Valley and from Central America. He sells 250,000 of the fish (3" to 4" long) annually to tropical fish wholesalers from Portland, OR to San Francisco, CA; shipped weekly by truck to Sacramento, and then by air to the various outlets.

RESOURCE

The geology of the area consists of large normal fault blocks, typical of the Basin and Range province. The Klamath Hills are typical of these fault blocks, allowing geothermal

waters that circulate at depth, and move to the surface in shallow aquifers. At the original location, a greenhouse complex consisting of four 6,000 square-foot buildings are heated using a peak of 400 gpm from six geothermal wells ranging in temperature from 80E to 200EF and all are around 100 feet deep. The newer set of ponds are provided geothermal water from a 460-foot deep well that pumps up to 300 gpm of 210EF water. The water surface in the newer well is at 120 feet and the lineshaft pump bowls are set at 190 feet. The water from the wells is alkaline with a pH of 8.8 out of the wells, but the chemical composition of the pond liners (diatomaceous earth) and soil surrounding the ponds reduce the pH to about 7.5 as the water flows through the system. The water is primarily a sodium-sulfate type of about 600 ppm that can be used directly in the ponds without harm to the fish. This is about the same chemical composition as the water of Lake Malawi.

UTILIZATION

At the greenhouse location, a 14,000-gallon steel railroad car tank is buried in the ground that receives water from one of the wells, and then supplies 180E to 185EF water to the greenhouses. Depending upon the outside temperature,

the water leaves the greenhouses at 165E to 180EF; where, it is then piped to Barnes' original ponds that are kept at nearly a constant temperature of 80EF \pm 3EF; even though, the fish can easily tolerate \pm 10EF. The wastewater from the ponds is then fed to a holding pond where it is cooled and then used for stock watering and irrigation. The water from the newer well is stored in a similar railroad car tank of 14,000 gallons and then gravity fed through a 4-inch diameter aluminum pipe adjacent to the ponds. Each pond is then supplied 197EF water through 1-inch CPVC pipe. It quickly mixes with the pond water, causing no harm to the fish, and levels out the pond water at around 80EF. The pond water is kept within 3EF of the desired temperature. The wastewater, that is not lost through evaporation and leakage, is disposed of into the same stock pond. The flow to the ponds varies from 50 to 300 gpm depending on the outside temperature and wind, with an annual average of about 100 gpm. A few of the ponds, which are in a more porous soil, have to be lined with black plastic to prevent severe water leakage.

The temperature and flow rate into the various ponds is controlled manually by feel. Gate valves at each pond are then set to achieve the proper temperature. This "hand feel" method is felt superior to electronic control valves, as these often stick open and thus, "fry" the fish. It is felt that pond temperature is kept with \pm 3°F, sufficient for optimum growth.

It is estimated that the installed capacity of the newer facility, based on a peak of 300 gpm and a 10°F-temperature drop in the water, is 1.5 million Btu/hr or 0.44 MWt. Using an annual average of 100 gpm, the total energy use is then 4.38 billion Btu/yr.

OPERATING COST

No cost figures are available for the original ponds constructed adjacent to the greenhouses. The new ponds and well construction in 1998 were funded by two Oregon Economic Development loans for a total of \$100,000. The well cost \$15,000 and the excavation for the ponds cost \$15,000. The remainder of the funds were used for controls, pumps, piping and storage tank. Operating cost at the original site is at a fixed rate of \$350 per month, since the resource is owned by Liskey Farms, Inc. There are no pumping power costs, since the ponds are filled with wastewater from the greenhouses. At the new location, the pumping power cost varies from \$280 to \$400 per month with an annual average of \$350 per month. The cost of electricity is 5.7 cents/kWh; thus, an average of 6,140 kW are used monthly. Approximately \$500 per month is used for repairs and maintenance. Thus, the total annual operating cost is approximately \$9,000. Barnes estimates that by using the geothermal heat energy, that he avoids the use of about 24 million kWh in electricity annually, for a savings of \$1,350,000.

REGULATORY/ENVIRONMENTAL ISSUES

The main concern originates from the Oregon Department of Fish and Game. They do not want any of the fish to escape into waterways in the area. As a result, a 200EF barrier is provided in the original pond area that would "cook"

any escaping fish. In the newer pond area, very little if any water overflows out of the ponds, and the little that does, mainly during the winter months, goes into a holding pond. Barnes is considering raising Tilapia and in this case, Fish and Game will require him to have a greenhouse type structure over the raising ponds and tanks to prevent any fish from escaping or being picked up and dropped by birds. The harvested fish cannot be shipped to market live, and thus must be killed and frozen on site before shipping. Also the Oregon Department of Environmental Quality would regulate the waste discharge from the Tilapia ponds; thus, a filter system would have to be installed, and a closed circuit system used. Water disposal from the tropic fish ponds is not a problem, as 500 lbs of fish per pond provide little waste. Discharge from over 20,000 lbs/year would be regulated by DEQ.

PROBLEMS AND SOLUTIONS

Four main problems exist at the facility: 1) lack of cold water for cooling the ponds; 2) corrosion in the aluminum pipes; 3) taking of fish by birds; and 4) limited capacity of the resource. Since, this is a geothermal area, cold water is a problem for both the greenhouse and aquaculture facilities. Cold water is then provided by cooling geothermal water in holding ponds. Internal corrosion in the aluminum pipe is a problem in the new facility due to the 195EF temperature of the water. In the facility adjacent to the greenhouses, the pipes have been in for over 20 years and have experienced no corrosion, as the water temperature is only 180EF. Black iron pipe placed under roads have experienced external corrosion from the soil. Birds are a problem at the older facility, since the ponds are adjacent to irrigation canals where Egrets and other birds live. This is not a major problem in the newer facility - so all that is really done at this point is to scare them away when they are working around the ponds. The maximum amount that can be pumped from the newer well is 300 gpm, and this is often reached during the winter months, especially when there is wind. This would then limited the size of the proposed Tilapia facility. Based on consultations with engineers at the Geo-Heat Center, they will experiment with two methods to reduce the evaporation. Since evaporation from the ponds can contribute to as much as 50 to 60% of the total heat loss, a wind barrier, and bubble mat pond cover are being considered. The bubble mat, similar to ones used for swimming pools and hot tubs, would cover a portion of the pond, since some of the pond area must be exposed to the air to provide oxygen to the fish. Various combination of 25, 50 and 75% pond coverage will be tried.

CONCLUSIONS

The "Gone Fishing" aquaculture operation appears to be successful, and plans are to expand from tropic fish to Tilapia. The success of the operation is due to two factors: 1) a readily source of geothermal energy, available at shallow depth with adequate temperature and flow; and 2) a operator/manager, Ron Barnes, who has the background and knowledge of aquaculture methods. He started small, and has increased in reasonable increments as he gained experience with using the geothermal resources. There are minor

problems with corrosion of metal pipes, and efficient use of the resource, but these are being solved, and do not present a major expense and management problems.

Lund, John W., 1994. "Agriculture & Aquaculture - Cascading the Geothermal Way" in, *Geo-Heat Center Quarterly Bulletin*, Vol. 16, No. 1 (November), Klamath Falls, OR, pp. 7-9.

REFERENCES

Clutter, Ted, 2002. "Out of Africa - Aquaculturist Ron Barnes Uses Geothermal Water in Southern Oregon to Rear Tropic Fish from African Rift Lake" in, *Geo-Heat Center Quarterly Bulletin*, Vol. 23, No. 3 (September), Klamath Falls, OR, pp. 6-8 [also published in *Geothermal Resources Council Bulletin* (Vol. 30, No. 2, March/April 2001), Davis, CA].

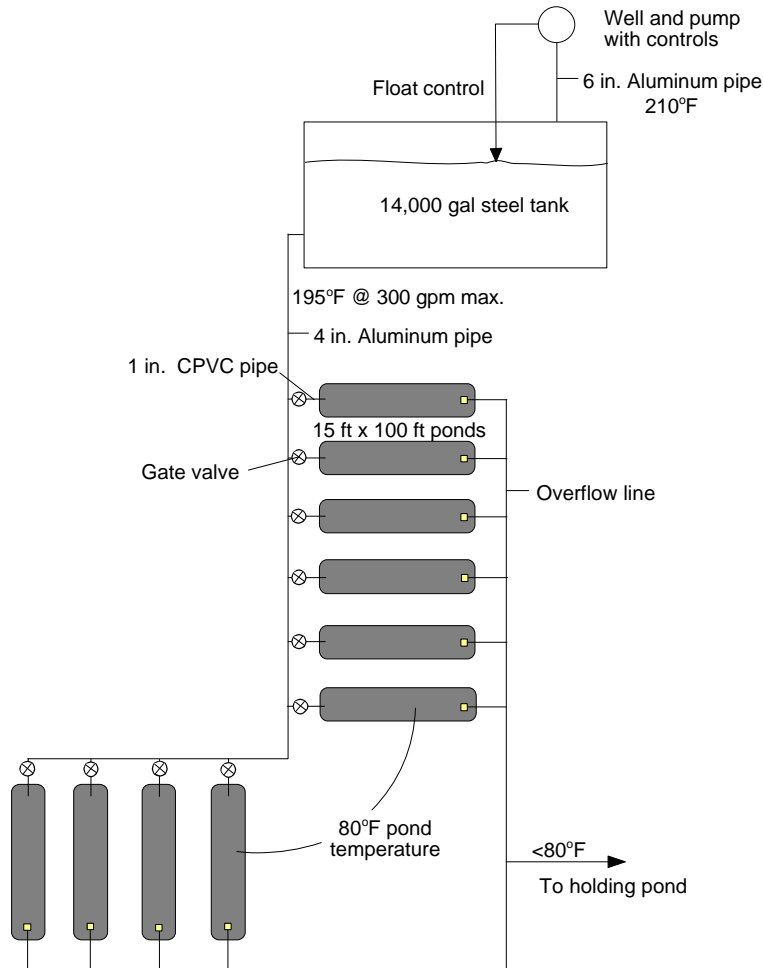

“Gone Fishing” - Schematic of the Newer Installation

GREENFUELS OF OREGON: GEOTHERMAL ENERGY UTILIZATION IN BIODIESEL PRODUCTION

Andrew Chiasson, Geo-Heat Center



INTRODUCTION

Greenfuels of Oregon is undertaking a new venture in the Klamath Basin to produce biodiesel using geothermal energy. The facility is currently under construction, but the production process is set up to make use of geothermal energy in the biodiesel process.

THE GEOTHERMAL RESOURCE AND DISTRIBUTION SYSTEM

The Greenfuels of Oregon biodiesel production facility is located on the “Liskey Ranch” (Figure 1), a Known Geothermal Resource Area (KGRA) that has seen a long history of geothermal energy usage since the 1970s. Current uses of geothermal energy on the Liskey Ranch include space heating, greenhouse heating, aquaculture pond heating, and now biodiesel production.

The geothermal resource has been described by Laskin (1978) and Lund (1994). The area is located near the northwest edge of the Basin and Range geological province, and thus the occurrence of geothermal water is controlled by geologic faults along the front of the Klamath Hills. These faults allow groundwater which has circulated to great depths to rise upward into shallower aquifers where it can be tapped by water wells. Groundwater temperatures available for utilization are on the order of 190 to 210°F, and wells on the property can produce geothermal water at several hundreds of gallons per minute.

THE GREENFUELS OF OREGON GEOTHERMAL SYSTEM

Greenfuels of Oregon makes extensive use of their geothermal resource for many heating purposes. Uses of geothermal energy include radiant floor space heating of the biodiesel production building, in addition to use in the pro-

duction of biodiesel itself. From the biodiesel facility, the geothermal water is cascaded to greenhouses when various organic vegetables are grown, and to an aquaculture operation.

WHAT IS BIODIESEL?

The Alternative Fuels Data Center of the U.S. Department of Energy defines biodiesel as a domestically produced, renewable fuel that can be manufactured from vegetable oils, animal fats, or recycled restaurant greases. Biodiesel is safe, biodegradable, and reduces air pollutants such as particulates, carbon monoxide, hydrocarbons, and air toxins. Blends of 20% biodiesel with 80% petroleum diesel (B20) can generally be used in unmodified diesel engines; however, users should consult their OEM (Original Equipment Manufacturer) and engine warranty statement. Biodiesel can also be used in its pure form (B100), but it may require certain engine modifications to avoid maintenance and performance problems and may not be suitable for wintertime use.

THE BIODIESEL PRODUCTION PROCESS

The general formula for making biodiesel is:

alcohol + vegetable oil or fat + heat + lye catalyst → biodiesel

The production process to be used by Greenfuels of Oregon is shown schematically in Figure 2. The process starts with some type of feedstock for the organic oil. Greenfuels of Oregon is currently set up for processing canola or soy beans with equipment shown in Figure 3 and 4.

The next stage of the process is to mix the organic vegetable oil with methanol and a sodium monoxide catalyst in the reactor, which is a 600-gallon tank. Heat is also added to the reactor through geothermal water at approximately 180°F

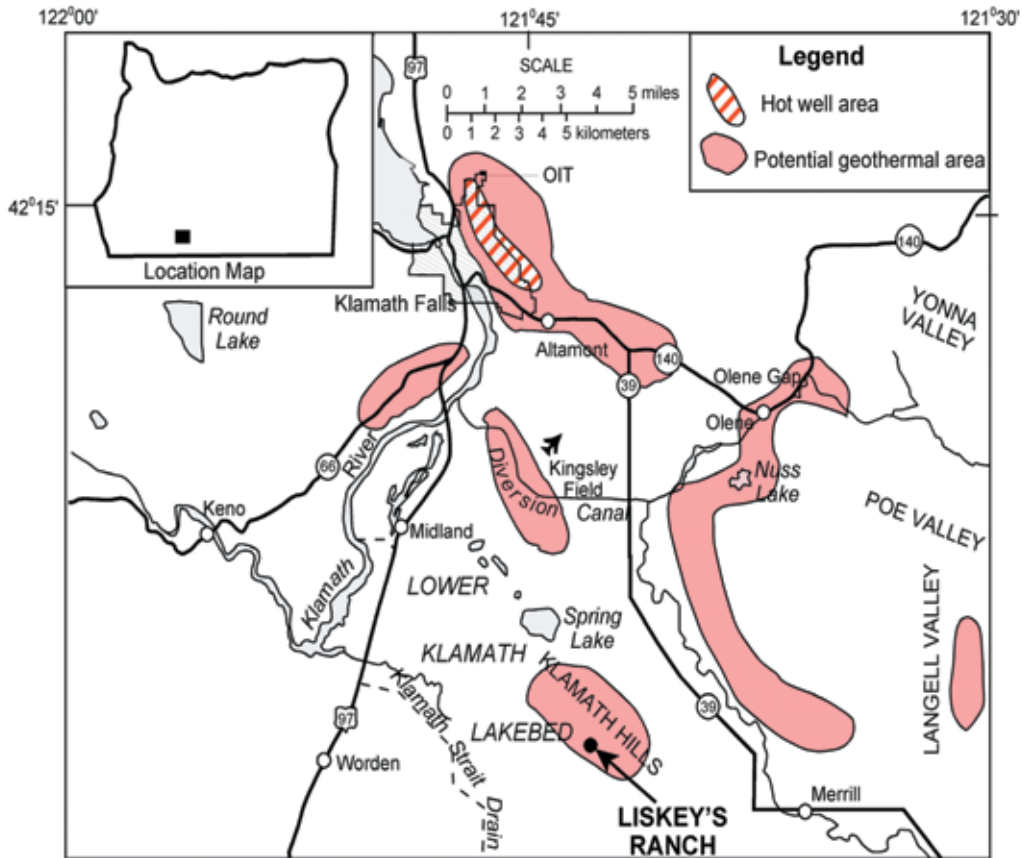

Figure 1. Location map of "Liskey Ranch".

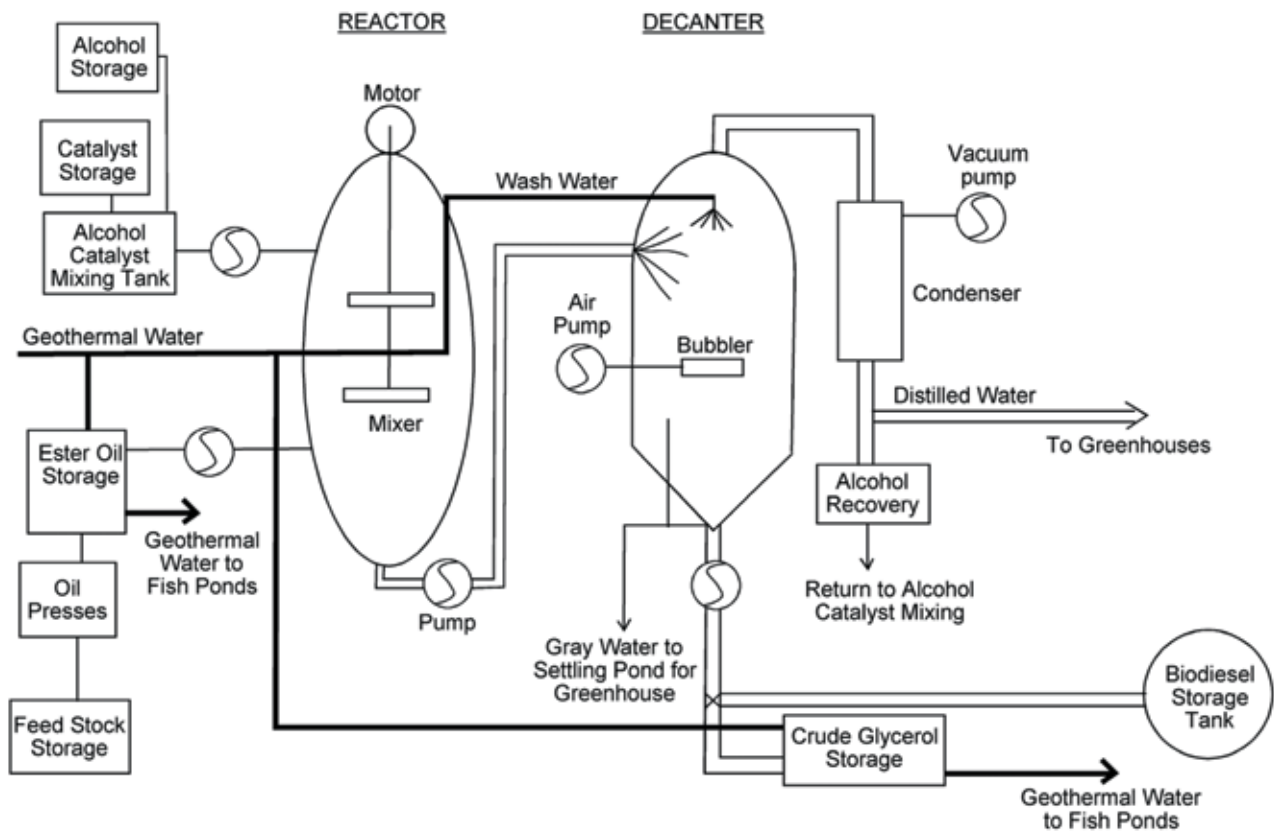

Figure 2. Schematic drawing of the biodiesel production process at Greenfuels of Oregon.

This process is formally called “transesterification” and occurs for approximately 30 minutes.

The mixture is then pumped to the decanter where geothermal water is used to “wash” and separate the finished biodiesel product from other materials. Distilled water and alcohol are recovered by vacuum pumping the decanter and then recondensing the vapors.

Geothermal gray-water is routed to settling ponds and then used in the greenhouses. Crude glycerol is a byproduct of the process. A photograph of the biodiesel production equipment is shown in Figure 5.

The biodiesel production target for Greenfuels of Oregon is about 1,500 gallons per day, but the actual production will depend upon feedstock availability. Most of the biodiesel is planned to be sold locally.



Figure 3. Feedstock grain storage silos.



Figure 4. Photograph of equipment for feedstock grinding.

CONCLUDING SUMMARY

Greenfuels of Oregon is undertaking a new use of geothermal energy in the Klamath Basin: production of biodiesel. In addition, geothermal energy will also be used for space heating of the building, and the geothermal water will be cascaded for use in greenhouse and aquaculture pond heating.



Figure 5. Photograph of the biodiesel production equipment.

There is on-going controversy in scientific literature about the energy balance of biodiesel production. In other words, there is a recurring question of whether it takes more energy to produce biodiesel than the energy that the biodiesel fuel produces. The Greenfuels of Oregon project in the Klamath Basin certainly requires a further examination of this question, and this will be the subject of future bulletin articles.

ACKNOWLEDGEMENTS

The Geo-Heat Center wishes to thank Rick Walsh for providing the information for this article, and Katja Winkler for providing the photographs of the equipment.

REFERENCES

- Laskin, S., 1978. Klamath Greenhouses. Geo-Heat Utilization Center Quarterly Bulletin, July 1978, Oregon Institute of Technology, Klamath Falls, Oregon.
- Lund, J., 1994. Agriculture & Aquaculture Cascading the Geothermal Way. Geo-Heat Center Quarterly Bulletin, November 1994, Oregon Institute of Technology, Klamath Falls, Oregon.

OREGON TRAIL MUSHROOMS

Gene Culver
Geo-Heat Center

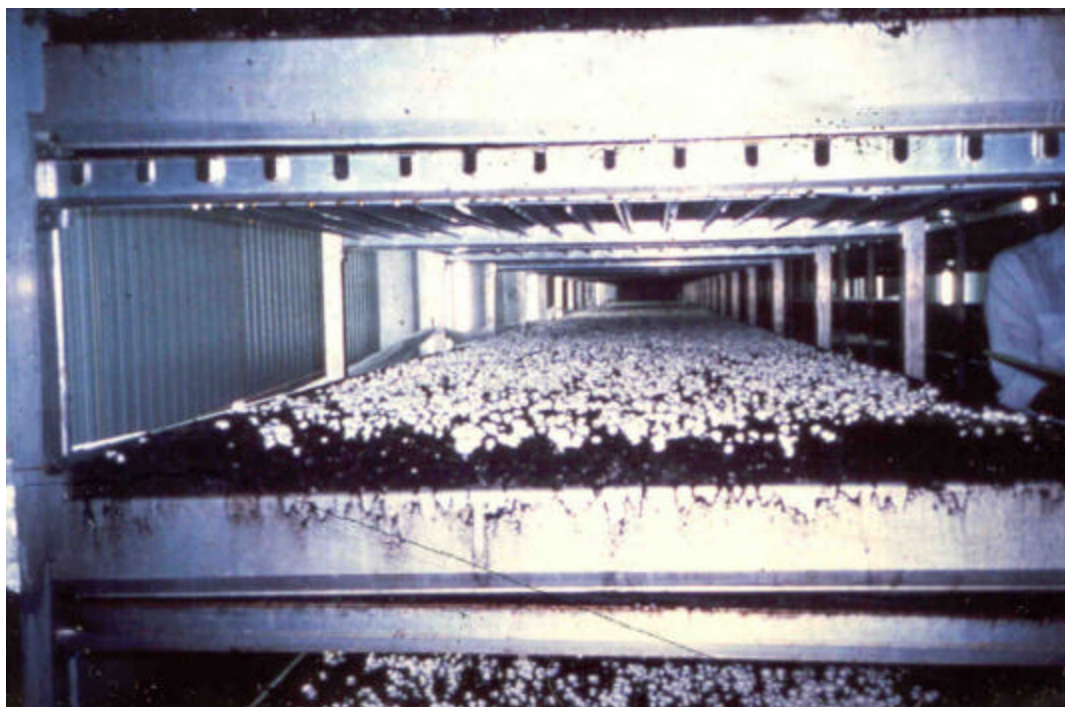

LOCATION

Oregon Trail Mushrooms is located on the east edge of Vale, Oregon, 15 miles west the Oregon-Idaho border. Elevation is about 2,240 ft. Winter temperatures reach -20°F and summer temperatures 100°F. The mushroom plant construction was financed through the USDOE Loan Guarantee Program and began production in 1986. Initially, 2,500 tons of white button mushrooms were produced annually. Production now includes other varieties and has increased to 4,000 tons annually. There are 130 employees year round.

RESOURCES

Vale has long been known for its geothermal resources. There are several hot springs in the area. The mushroom plant is on the previous site of hot springs. A geothermally-heated greenhouse, and a slaughter house still utilizes geothermal hot water for cleaning and hog scalding. There was a large geothermal swimming pool and sanatorium just across the highway and several nearby homes also utilize the hot water. Temperature of 198.5°F with total springs flow of 20 gpm and a 140-ft well were reported by Russell in 1903. Today, wells that more accurately target the resources have temperatures above 220°F. In the hotter wells, pH ranges from 7.2 to 8.3, TDS is about 1,000 with SiO₂ 74 to 113 ppm, Cl about 370 ppm and F 6.1 to 6.6 ppm.

The resource appears to be the result of deep circulating water rising along fractures in completely silicified sandstone and conglomerates along the Willow Creek fault

zone. Although there is anomalous heat flow (at least 3 times the surrounding area) in an area about two miles wide and 10 miles long along the fault zone, the only surface manifestations and 29 wells are in an area of about 40 acres between the northern end of Reinhardt Buttes and the Malheur River (Gannett, 1988).

UTILIZATION

250 gpm of geothermal fluid at 220°F is pumped from one 250-ft deep well by an oil-lubricated vertical lineshaft 20-hp pump. A similar well with a 10-hp pump is available as standby. Geothermal fluid flows through two plate-and-frame titanium heat exchangers in series, which supply 213°F hot water to a 400-ton lithium bromide chiller and growing room where fan coil units are supplied with 191°F hot and 40°F chilled water via a 4-pipe system. The geothermal effluent is also provided to five homes for space and domestic hot water heating, a swimming pool located about one mile away in the city and to a corn dryer (in season), and/or injected into two injection wells.

The growing medium, a mixture of wheat straw, chicken manure, gypsum, alfalfa seed screenings and urea is composted off site and trucked to the plant. The compost is then moved by conveyor to one of three pasteurizing rooms; where, it is held for a 7-day controlled heating and cooling schedule. Maximum pasteurizing temperature is 140°F. Air is forced through the compost via tunnels and grated floors. After pasteurization, the compost is moved to the growing rooms by conveyor. There are 42 growing rooms, each 20 ft

wide, 85 ft long and 12 ft high with removable ends to facilitate conveying compost in and out. Compost is loaded into six shelves on either side of a corridor providing a growing area of 4,320 ft² per room. Spawn is added and the room is held at 80°F and 94% relative humidity for 35 days when the first crop is harvested. Rooms are held at 64°F and 94% relative humidity for a 21-day growing period during which three crops are harvested. Harvesting is done by hand. Temperature and humidity are closely controlled by a central computer system. After harvesting, mushrooms are sent to chill rooms for sorting, packaging and storage awaiting shipment. Chill and storage areas are cooled by centrifugal (electric) chillers.

The geothermal system provides about 5×10^6 Btu/hr (1.47 MWt) (depending on outdoor air conditions) and replaces about 430,000 therms of natural gas annually to the mushroom facility; plus provides heat for the homes, pool and corn drier.

OPERATING COSTS

Operating costs for the geothermal system are minimal. Geothermal fluids are limited to the two heat exchangers and a small amount of piping. There have been no problems with the piping, but one set of pump bowls have been replaced since plant startup. Stainless steel plates in the heat exchangers were replaced with titanium and there has been no problems, not even cleaning since then. Maintenance personnel stated that it cost less than \$500 per month to operate the chiller including maintenance and pumping, and that a chiller of equal duty would cost at least \$500 per week.

REGULATORY/ENVIRONMENTAL ISSUES

None after obtaining production and injection well permits.

PROBLEMS AND SOLUTIONS

Shortly after plant startup, it was noted that wells supplying the five homes, the corn drier and a slaughter house were declining in both water levels and temperatures. Oregon Trail Mushrooms obtained the water rights for the five home wells in exchange for a guaranteed supply of effluent water sufficient to meet their needs. They no longer have pumping nor pump and well maintenance costs. The corn drier owner

maintains his rights, but agreed not to pump so long as he is supplied with sufficient effluent. All effluent ultimately is injected into Oregon Trail's injections wells. Since the homes and drier wells are not used, the slaughter house well has stabilized and the owner continues on his original system. The remainder of the 29 wells in the immediate area are not used.

As noted above, there were problems with the stainless steel heat exchangers leaking at the gaskets. Converting to titanium has solved the problem.

At plant startup, the temperature at the production wells was 228°F. This has dropped to 220°F, probably due to lower water levels allowing cool water intrusion from the river, the injection wells, or the other side of the fault where wells were historically cooler by 20 - 40°F. The temperature drop caused a decrease in the capacity of the lithium bromide chiller. This was somewhat offset by running chilled water through the heating coils when cooling the grow rooms. Also, when a few of the coils needed replacing, higher capacity coils were installed. Now they plan to add more grow rooms—hence, the recent installation of a booster boiler in the closed chiller circuit. It has not yet been operated except for testing. Also planned are modifications to the piping to handle additional load and changing fan coils to increase efficiency.

CONCLUSIONS

This is a very successful project that is the result of the USDOE Loan Guarantee Program. The plant has expanded and increased production since startup and continues to expand.

Lithium bromide chillers, while not common in geothermal applications, are economical where temperatures of 220°F are available.

Where there is interference between wells of a number of owners and uses, reasonable people can probably reach an agreement that is beneficial to all.

REFERENCES

Gannett, Marshall W., 1988. "Hydrogeologic Assessment of the Developed Aquifer Near Vale, Oregon." State of Oregon Water Resources Department. Open-File Report No. 88-04.

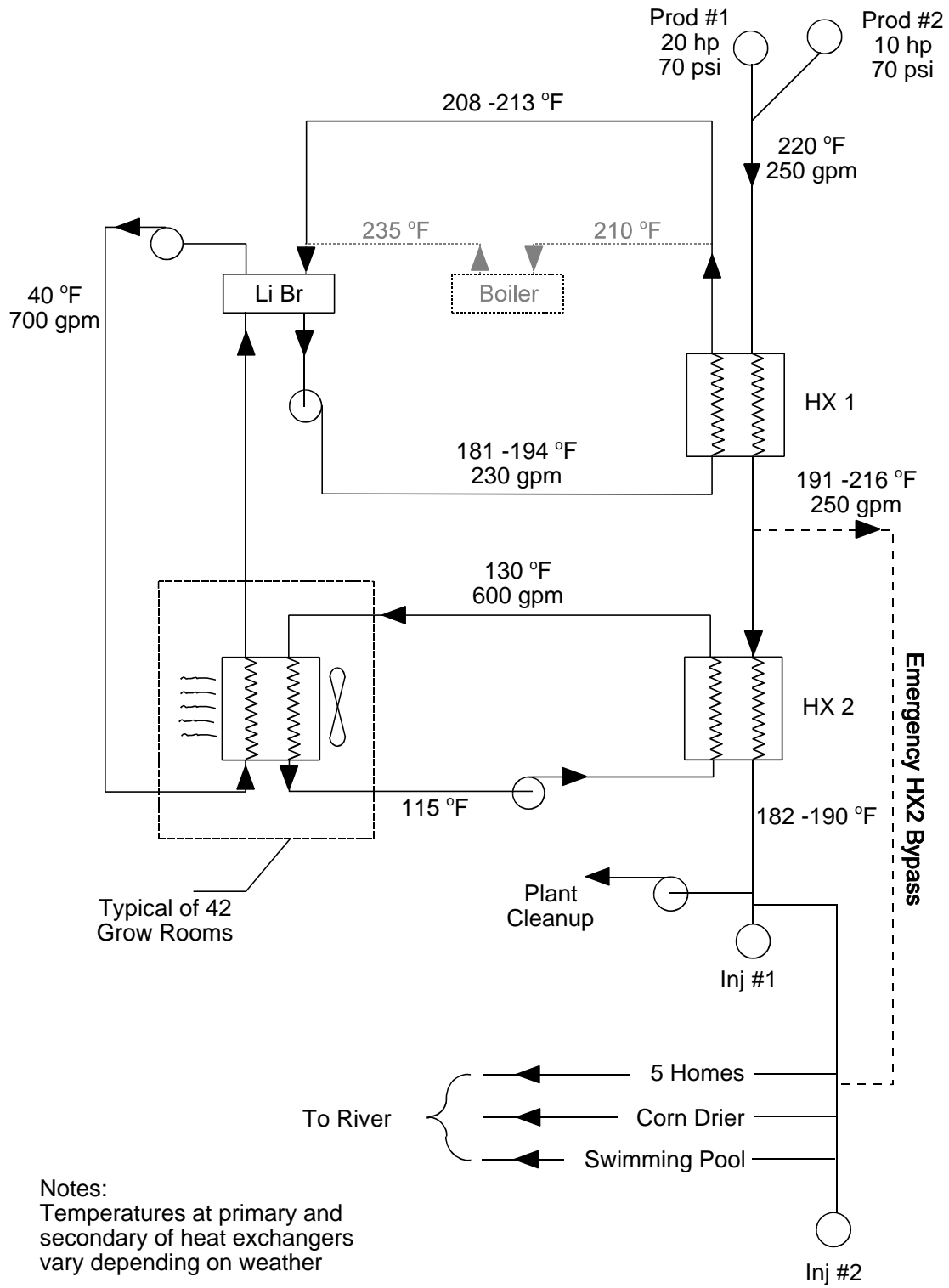

CHILOQUIN COMMUNITY CENTER CHILOQUIN, OREGON

Andrew Chiasson
Geo-Heat Center



LOCATION & BACKGROUND

The Chiloquin Community Center is located in Chiloquin, Oregon, which is in southern Oregon, about 30 miles (48 km) north of Klamath Falls, and about 250 miles (402 km) south of Portland. It is a single-level, 13,000 ft² (1,210 m²) structure that provides space for the Chiloquin Public Library, the Two Rivers Art Gallery, public arts and crafts work-rooms, a large public meeting room with full kitchen, and also leases offices to the local Sheriff's Department. Portions of the building are in use 7 days per week, year round. A sketch of the building footprint and borefield are shown in Figure 1.

The building is constructed of insulated concrete form (ICF) walls and a conventional wood frame roof. As a consequence of using ICF with fixed windows, the building is extremely well insulated and air-tight. The entire slab is insulated using 1-inch polystyrene board to reduce downward heat loss in winter.

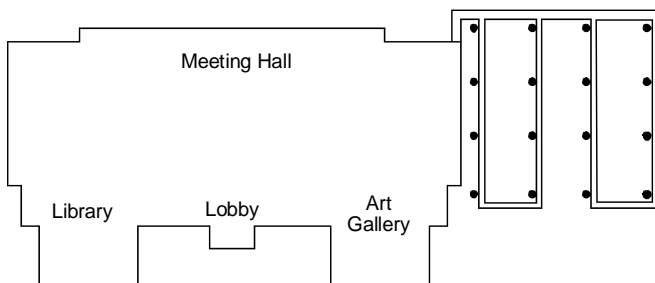

Figure 1. Chiloquin Community Center site sketch showing ground loop field.

The building was constructed in 2003-2004, and formally opened in the Spring of 2004. The ground-source heat pump system installation began prior to the commencement of the main building with the drilling of the network of vertical bores comprising the earth heat exchanger for the facility.

Average high temperatures in the area in July are about 85°F (29.4°C) and average low temperatures in January are about 22°F (-5.6°C). There are approximately 7000 (3890°C-day) heating degree days and 200 (110°C-day) cooling degree days per year (65 °F (18°C) base).

SYSTEM DESCRIPTION

Ground Source System

The ground source system (shown in Figure 1) is a vertical network of 16 bores, each 6-inch (152-mm) diameter and 320 ft (98 m) deep, and arranged in a rectangular grid with a bore-to-bore spacing of 20 ft (6.1 m). The u-tube assemblies were fabricated using 1" (25.4 mm) diameter high-density polyethylene pipe (HDPE). Following insertion of the u-tubes, a bentonite/silica sand grout was pumped into the bores to achieve a nominal grout thermal conductivity of 1.0 Btu/hr-ft-°F (1.7 W/m-°C).

To aid in the design of the borefield, an in-situ thermal conductivity analysis was performed on a test bore. The resulting test data were used to determine that the average thermal conductivity of the earth surrounding the bore is approximately 0.62 Btu/hr-ft-°F (1.07 W/m-°C). The mean earth temperature was measured at 56°F (13.3°C).

The geology at the site, based on the drilling logs, consists of sands and gravels to a depth of approximately 16 ft (4.9 m), with the remainder of the bore depths consisting of gray clay deposits interspersed with occasional sandstone

layers. The drilling was accomplished using air-rotary methods (Figure 2).



Figure 2. Photograph of drilling activities

Interior System

A highly unusual integrated system design was conceived for the project that addressed the energy efficiency goals of the building owners, and built on the very high thermal integrity of the shell. A crucial initial step in this process was agreement on design criteria that allowed for a wider range of indoor air temperatures than is typical for a building of this type. This determination facilitated the choice to use radiant floor heating as the primary means of thermal distribution, and this concept was then extended to include radiant floor cooling.

The building's 15 control zones are connected by a hydronic piping system to a central plant that has only one heat pump. The heat pump is a water-to-water unit (Figure 3) with a nominal rating of 15 tons (53 kW), and is equipped with a single compressor and refrigerant circuit. To prevent short-cycling, a thermal energy storage tank (Figure 4) is employed on the building side of the heat pump a significant buffer volume and de-coupling the control of building water distribution from the operation of the heat pump.

Because the building has no operable windows, all ventilation air is provided by mechanical means. A heat-wheel type air handling unit with a nominal capacity of 4000 cubic feet per minute (cfm) (6,800 m³/hr) is installed in the attic space, together with ducting to distribute the air to each zone. At the zonal level, occupancy sensors operate a damper in the ventilation duct to minimizing the air handled by the fan system. These occupancy sensors also control lighting in the individual zones. The fan speed is modulated by means of variable frequency drives.



Figure 3. Photograph of the 15 ton water-water heat pump serving the entire building. Note the storage tank on the right.

The building's hydronic circulation pumps are in-line centrifugal types, with variable frequency drives that are controlled based on pressure in the supply pipe. At the heat pump, the ground loop pump is also controlled with a variable frequency drive. The tank circulation pump between heat pump and thermal storage tank is constant speed.



Figure 4. Photograph of the mechanical room, showing the distribution piping and storage tank.

To allow the programming of desired control sequences, a direct-digital control (DDC) system was installed. The system uses ASHRAE's BACnet communications protocol set over TCP/IP. It is therefore possible to use conventional internet browser software to access and interact with the control system, and a dedicated server is located in the building to accomplish this task.

PROJECT COSTS

The installed cost of the interior HVAC system was \$189,400 or \$14.57/ft² (156.83/m²) and the cost of the ground loop was approximately \$48,000 or \$9.38/ft

(\$30.77/m) of vertical borehole. Thus, the total installed cost of the entire ground-source heat pump system was \$237,400 or \$18.26/ft² (196.55/m²).

PacifiCorp provided incentives to the owners, underwriting the costs of pre-design analysis and construction. Additional efficiency incentives were provided through the State of Oregon's Business Energy Tax Credit (BETC) program. Together these incentives totaled approximately \$80,000.

SYSTEM PERFORMANCE AND OPERATING COST

The first full year of operation has just completed, and the building has proven itself to be even more efficient than anticipated. Average energy use index is 19,800 Btu/ft²/yr or 5.8 kWh/ft²/yr (62.4 kWh/m²/yr), which is especially impressive because the building operates with no night setback due to the dynamics of the radiant slab.

Sub-metering of the building zones allows the HVAC energy costs to be broken out and tracked. From utility bills, the operating cost of the HVAC system for the first year was about \$5,350 or \$0.41/ft² (\$4.41/m²).

OPERATING EXPERIENCES

Chiloquin Visions in Progress (CVIP), a non-profit organization who raised funds to construct the building, report that they are very happy with the low energy use and operating cost of the building. Low operating costs are an especially attractive feature for non-profit organizations.

As anticipated, the building design does not provide for rapid adjustment to load changes with its radiant slab heating/cooling systems. This might be perceived as a drawback, but the building has no morning warm-up or cool-down time since it is operated without night setback of thermostatic controls. As designed, it seems to work reasonably well with the normal functional requirements of the building.

One rapid load change scenario that has been somewhat difficult to deal with is the occasional large public gathering in the meeting hall room. To best provide for the sudden cooling load, it has been necessary to anticipate the event by overcooling the room, and then keeping the supply water temperature lower than would normally be called for at the central thermal storage tank. In addition, decorative ceiling fans have been proposed in the meeting hall room to increase air circulation as well as to give occupants a visual perception of air movement.

ACKNOWLEDGEMENTS

The Geo-Heat Center wishes to thank Gene Johnson of Solarc Architecture and Engineering, Inc. for providing the data and information for this case study, and Chuck Wells and Jim Walthers of CVIP for providing the drilling and utility cost information.

OVERALL SUMMARY

Building Description:

Location: Chiloquin, Oregon

Occupancy: Community Center with continuous occupancy in some zones

Gross Floor Area: 13,000 ft² (1,210 m²)

Number of Floors: 1

Type of Construction: New

Completion Date: 2003

July Avg. High Temp.: 85°F (29.4°C)

Jan Avg. Low Temp.: 22°F (-5.6°C)

Annual Heating Degree Days: 7000°F-day (3890°C-day)

Annual Cooling Degree Days: 200°F-day (110°C-day)

Interior System:

Total Installed Heat Pump Capacity: 15 tons (53 kW)

No. of Heat Pump Units: 1

Pumping System: Central pumping, variable speed control

Additional notes: Radiant floor heating and cooling

Ground-Source System:

Geologic Materials: Sediments

Mean Ann. Ground Temp.: 56°F (13.3°C)

Type: Vertical closed loop, single U-tube

Configuration: 16 boreholes (4x4 grid pattern)

300 ft (98 m) deep, 20 (6.1 m) ft spacing

Borehole per ton: 342 ft/ton (29.6 m/kW)

Heat Transfer Fluid: Methanol/water solution

Economic Analysis:

Installed Geothermal HVAC Capital Cost:

\$237,400 (\$18.26/ft²) (196.55/m²)

Estimated Conventional HVAC Capital Cost:

\$130,000 (\$10.00/ft²) (107.64/m²)

Annual HVAC Energy Use:

19,800 Btu/ft² (62.4 kWh/m²)

Annual HVAC Energy Cost:

\$5,350 (\$0.41/ft²) (\$4.41/m²)

RESIDENTIAL DOWNHOLE HEAT EXCHANGER KLAMATH FALLS, OREGON

John W. Lund
Geo-Heat Center



Well with three DHEs, a single 2-in. (5-cm) pipe used for space heating and two 3/4-in. (2-cm) pipes used for domestic hot water.

LOCATION

Klamath Falls, Oregon is located on the western edge of the Basin and Range physiographic province on the east flank of the Cascades approximately 30 miles north of the California border. It is located in a graben structure about 10 miles wide flanked by horst blocks rising over a 1,500 feet with steeply dipping normal faults trending in a northwest-southeast direction. Upper Klamath Lake, a shallow body of water about 35 miles long, dominates the graben.

RESOURCE

Geothermal wells and springs are widespread in the Klamath Falls area. The springs were prevalent over 100 years ago and were used by the Indians and early European settlers. However, due to pumping from wells, all of the springs no longer flow on the surface. Today more than 500 hot water wells have been drilled in the area, most of which are located along the eastern edge of the graben tapping into the upflow zones along the fault system. Hot water, heated at depth, migrates up along these fracture zones and then flows southwesterly in permeable zones of volcanic cinders and fractured lava flows. Wells were drilled in the area, starting around 1930, to provide space heating for local residences using downhole heat exchangers (DHE). These DHEs consist of a closed loop of pipe in the well with city water in them extracting heat from the well water. The DHE conserve the resource by extracting only heat from the well water, and can provide space heating and domestic hot water to individual

homes, several homes or even schools and businesses in the area. A typical residential well can provide up to about 250,000 Btu/hr (0.1 MWt) of energy, and installations with multiple DHE, such as for schools, provide about 10 times this amount of energy. Well depths in the city vary from 100 to 1,800 feet, with 300 feet being the average. Temperatures vary from 120 to 220°F, with 140°F and above considered desirable for providing sufficient energy using a DHE.

UTILIZATION

The DHE example selected from Klamath Falls serves two residences from a single well. The system design is fairly simple, but typical of others in the city that provides both space and domestic hot water heating. The well is 200 feet deep, with a temperature of 196°F at the top, and 204°F at the bottom (when drilled). The static water level is 75 below the casing top. The well was drilled in 1954 and cased to the bottom with a 10-inch diameter casing, which is perforated just below the water surface and at the bottom of the well in the live water area. The perforations are about 0.5 inches wide and 6 inches long for a total distance of about 15 feet at each location. The casing is sealed with cement from the surface down to 21 feet, and then the annulus is open below this point providing about a 1-inch clearance. The perforations and opening between the casing and wellbore allows a vertical convection cell to develop, bringing the hotter water from the aquifer (live water zone) at the bottom to the top.

Originally there were four DHEs in the well, two 2-inch diameter closed-loop pipes for the space heating and two 3/4-inch diameter open loop pipes for the domestic hot water heating—one set for each home. After 19 years of service (1974), the black iron pipes were replaced due to corrosion at the water line. The two 2-inch diameter heating loops were replaced with a single 2-inch diameter heating loop which is now shared by both homes. Since the domestic hot water is a consumptive system, the two loops for this system were retained.

The space heating system consists of baseboard hot water radiators on a two-pipe system with flow control valves on each heating unit. A motorized valve on the return leg of the heating loop controls the flow via a thermostat. Recently, a solid state controller hooked to a storage battery was installed in case of a power failure. A 10-gallon expansion tank is connected to the high point in the heating system, and pressure reducing and relief valves are part of the cold water supply line used to initially fill the heating loop. City water is also provided to the domestic hot water loops in an open system. There is no storage tank for the domestic hot water, and there is also no circulation pump on the space heating loop, as the circulation is produced by normal thermal syphoning.

The estimated utilization of the system for both houses is about 164 million Btu/yr (48,000 kWh). The maximum capacity of the well is probably 10 times this utilization, but obviously it has not been plumbed or tested to this amount, which depends upon the aquifer flow and efficiency of the vertical convection cell.

OPERATING COST

The original cost of the well was \$2,400 and \$800 for the DHE for each house. Thus, each homeowner paid about \$2,000 for the system. At today's prices, the well would cost around \$10,000 and \$3,000 for the three DHEs. The annual O & M cost are only for the electricity to run the motorized valve and the equivalent annual cost of replace parts of the DHE on about a 25-year intervals, amounting to probably less than \$100 per year. The estimated annual heating and domestic hot water cost for the two homes at about 4,500 sq ft total of heated space using natural gas would be about \$1,800 per year or \$2,900 per year for electricity, plus \$5,000 for the capital cost of two furnaces and hot water heaters. This would give a simple payback of five and three years, respectively.

ENVIRONMENTAL IMPACT

Initially, to prevent corrosion of the DHEs at the water-air interface, several pounds of paraffin were placed in the well. This was considered a pollutant to the groundwater; thus in 1974, after the DHEs were replaced, a steel plate was welded to the top of the water to limit air (oxygen) entering the wellbore. This is the recommended procedure today.

REGULATORY ISSUES

Drilling a geothermal well with less than 250°F temperature is under the jurisdiction of the Oregon Department of Water Resources (DWR). Wells that exceed this value are under the jurisdiction of the Department of Geology and Mineral Industries (DOGAMI). A drilling log must be filed by the driller to the state (DWR) once the well is completed. The well casing must also be sealed from the surface down to competent formation or to 21 feet below the surface. The city of Klamath Falls passed an ordinance in 1990 to prevent the dumping of geothermal water in the storm sewer or waterways—all water must be reinjected into the same aquifer. Since only heat is removed from a well using DHE, this ordinance does not apply.

PROBLEMS AND SOLUTIONS

The only major problem was the corrosion of the DHEs at the air-water interface. These were replaced in 1974 at a cost of about \$500. The homeowners were able to save on purchasing new pipe, as the two space heating DHEs, were replaced with a single DHE. There has been no corrosion problems since this date. Typical life of DHE in Klamath Falls wells average 14 years. Recently, the pressure reducing and pressure relief valves on the city water supply side connected to the closed loop DHE had to be replaced; as, they were causing high pressure in the system, producing leaks.

CONCLUSIONS

This system has been operating with few maintenance problems and low annual costs. This is an ideal configuration providing the resource temperature is at least 140°F. It also conserves the resource as only heat is removed from the water. The design of these system is extremely simple; however, more complex systems can be found in the city and are documented in the reference below.

REFERENCES

Geo-Heat Center Quarterly Bulletin, Vol. 20, No. 3 (September 1999). "Downhole Heat Exchangers," Klamath Falls, OR, 28 p. (available on the GHC website: <http://geoheat.oit.edu/bulletin/bull20-3/bull20-3.pdf>).

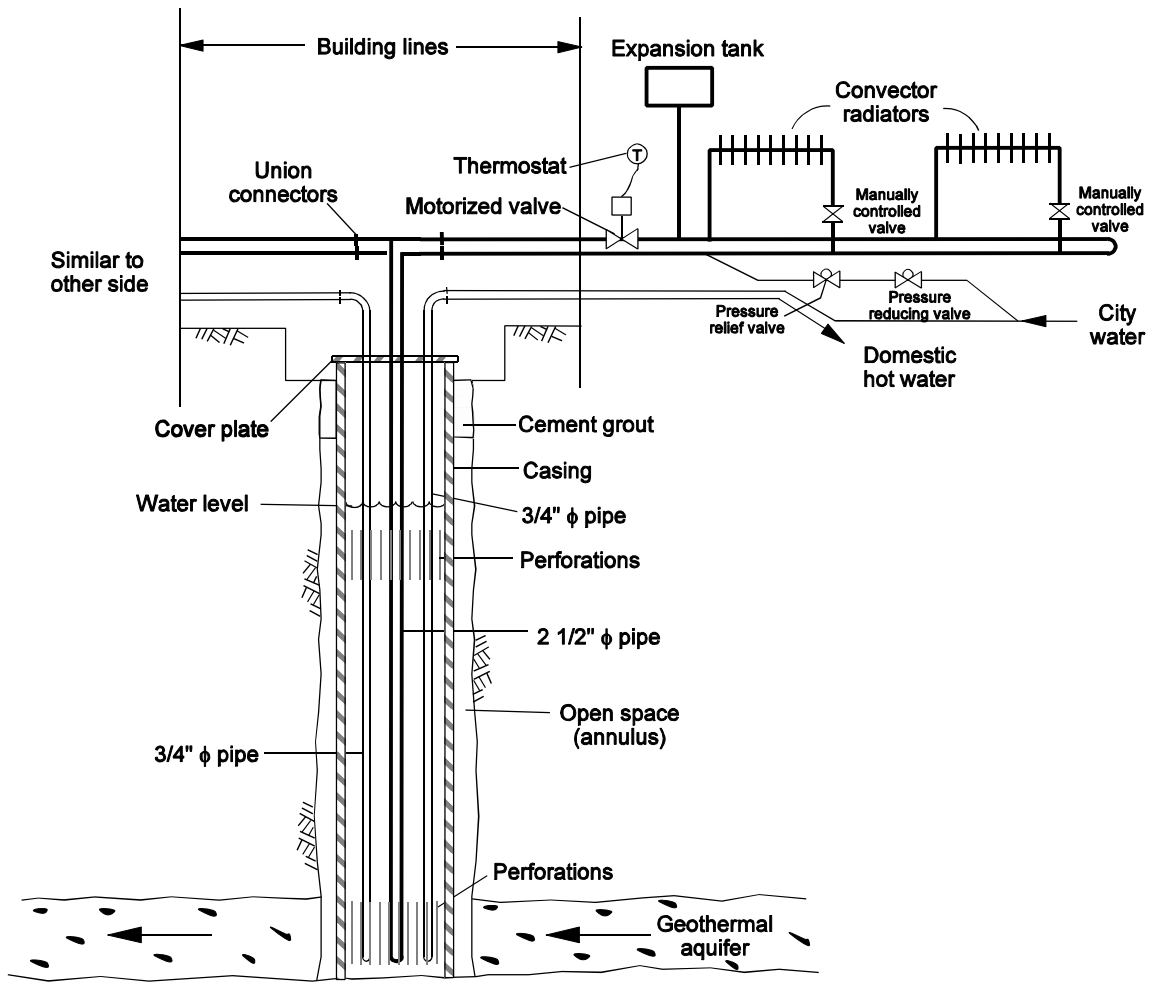

Diagram of the entire system for the basic installation.

MERLE WEST MEDICAL CENTER KLAMATH FALLS, OREGON



LOCATION

The Merle West Medical Center (MWMC) (formerly Presbyterian Intercommunity Hospital) is located in Klamath Falls which is in south-central Oregon. Elevation at Klamath Falls is approximately 4,100 ft and the local climate is characterized by an annual total of 6,500 heating degree days. The medical center complex is adjacent to the Oregon Institute of Technology (OIT) campus at the north end of the city of Klamath Falls. The hospital was originally constructed in 1964 and the geothermal system was added as a retrofit in 1976. Numerous building additions have been completed since--virtually all geothermally-heated.

RESOURCE

The MWMC produces from the same aquifer serving the OIT campus and most of the other 550 geothermal wells in Klamath Falls. The water issues from a northwest trending fault bordering the east side of town. Water flows in a generally southwest direction from the fault mixing with cooler surface water as it proceeds. Temperature of the water tends to reach a maximum of approximately 220°F nearest the fault. Water chemistry is relatively benign with a pH of approximately 8 and TDS of 800 to 1,000 ppm. Despite this, isolation is typically employed, since the fluid does contain a small amount (approx. 0.5 ppm) of hydrogen sulphide.

MWMC is served by a single production well 1,583 ft in depth with a static level of 332 ft. The well was originally tested at a flow of 500 gpm of 195°F water with a drawdown of 15 ft.

UTILIZATION

The original geothermal system for MWMC was designed to provide space heat and domestic hot water to the 96,000-sq ft main building; a new 56,000-sq-ft addition; the adjacent 56,000-sq ft nursing home and snow melting for the main entrance area. Since that time, the approximate areas heated have grown to include 300,000-sq-ft main building; 45,000-sq-ft medical office building; 56,000-sq-ft nursing home and a 80,000-sq-ft residential care facility. The system as indicated in the attached schematic includes a production well producing a peak flow of 600 gpm of 195°F water and equipped with a 125-hp motor. The well pump is controlled to maintain a constant pressure at the upper end of the system. The water is delivered to a complex of six heat exchangers in the main building, one in the residential care facility and two in the medical office building. In all cases, loads are arranged in series such that a maximum delta T can be achieved. In general, flow control at each heat exchanger is provided by a 3-way valve which serves to either divert geothermal water through the heat exchanger or past it to subsequent loads.

After passing through the plate heat exchangers, the fluid is delivered either to a final snow-melt system or diverted to the injection well collection tank. Two 15-hp injection booster pumps provide the pressure necessary to deliver the water to the injection well. The injection well is 1912 ft deep and was added to the system in 1990 (see regulatory section).

The estimated peak heating load for the buildings is 21 million Btu/hr (6.1 MWT) and the annual use is 22 billion Btu.

OPERATING COSTS

Operating costs specific to the geothermal system are not maintained by MWMC. For purposes of accounting, however, costs are apportioned to different individual sub-facilities comprising the MWMC. For example, the 80,000-sq-ft residential care facility is billed approximately \$0.024 per sq ft monthly to cover maintenance and capital improvements to the geothermal system. In addition, they are billed for the heat consumed as measured by an energy meter. Similar arrangements are in place for the other two major stand alone buildings.

The actual electrical energy input for the system in terms of operation is quite small relative to the quantity of energy produced. Based on an approximate design capacity of 21,000,000 Btu/hr, a total pumping requirement of only 165 hp is needed. The geothermal pumping is not separately metered but calculations indicate that approximately 430,000 kWh would be required on an annual basis to operate the systems production, snow melt and injection pumps.

The MWMC engineering department performs all regular maintenance of the system and its director estimates that the equivalent of one full-time employee is required to handle the maintenance of the geothermal system.

REGULATORY/ENVIRONMENTAL ISSUES

Few regulatory issues are associated with the operation of a system like this in the state of Oregon. Well drilling and construction is permitted in the same way as normal water wells with a start card and well completion report required to be submitted to the Department of Water Resources. Since the system is located within the city limits of Klamath Falls, injection is the required method of disposal. The ordinance requiring injection was passed in 1985 and stipulated that all existing systems would have to commence injection by 1990. As a result, MWMC completed a well for injection in 1990 to comply with the ordinance. Prior to that time, effluent was disposed of on the surface with drainage to Klamath Lake. Due to the age of the system, no permits were required. Injection requires only the submission of a one page summary form to the Department of Environmental Quality.

PROBLEMS AND SOLUTIONS

The MWMC system has been in operation for nearly 25 years. In that period of time, numerous modifications have been made to the system some as the result of problems and

some as the result of newly available equipment. The original design included a well pump controlled by a fluid coupling type of speed control. The well pump produced into a 4,000-gallon tank that was vented to atmosphere and from that point to the individual heat exchangers. Relatively frequent well pump failures were experienced for a time and this was thought to be the result of a control sequence that maintained the pump in operation but at a speed that was insufficient to produce flow at the well head. The control was reset to eliminate this mode of operation and pump life was then extended to an average of six years between overhauls where it remains today. In 1995, the pump was overhauled with a variable-frequency drive for speed control and the tank was removed from the system entirely. The original design employed all shell and tube heat exchangers. This equipment was much larger than the current plate heat exchangers, more difficult to clean and less effective at heat transfer. In the mid-1980s, all of the original heat exchangers were replaced with plate and frame units. There has been some problems encountered with gaskets in the plate heat exchangers. Swelling has been encountered in some cases and this is thought to possibly be related to the small amount of oil in the geothermal fluid from the well pump (oil lubricated enclosed shaft type). Some problems have also been encountered with butterfly valve lining material. Fluoroelastomer lined valves have been used but the cost is excessive and this problem is yet to be fully resolved. The injection system involves the use of a concrete sump in which "can" type vertical pumps are located. Originally, these pumps were standard, steel column, cast iron bronze fitted pumps. Due to the fact that the geothermal fluid is saturated with oxygen at this point in the system, the original pumps were plagued with failures. All stainless steel pumps were installed and these problems have largely been eliminated. A similar situation and remedy was experienced with the snow melt pumps located just upstream of the injection pumps. The original controls for the system were the standard pneumatic design of the day. These were replaced with a DDC system in 1990 and the operation and monitoring of the system was vastly improved according to the MWMC engineering department.

CONCLUSION

The MWMC system is one of the oldest large geothermal systems in the U.S. It has proven to be a reliable energy source for a critical facility for the past 25 years and has in the process accommodated substantial increases in capacity. The system currently displaces approximately 275,000 therms per year in natural gas purchases. In 1977, the total investment in the geothermal retrofit of \$320,000 was expected to generate annual savings of approximately \$104,000 per year when all additions envisioned then (total building area 275,000 sq ft) were completed. At this writing, the system is serving approximately 470,000 sq ft and as a result the savings have re-paid the original cost many times over.

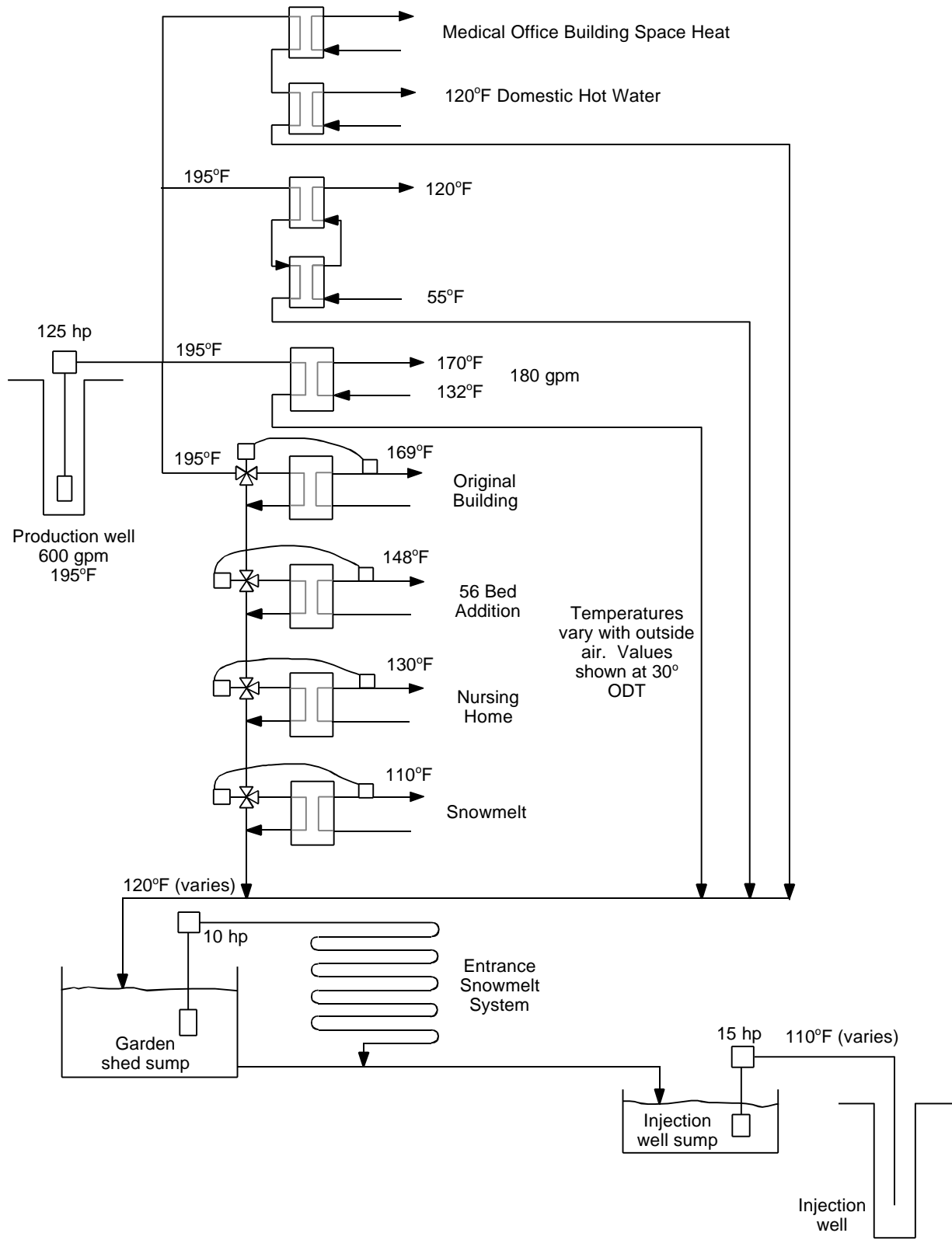

Merle West Medical Center Geothermal Schematic

KLAMATH COUNTY VANDENBERG ROAD COMPLEX

Gene Culver
Geo-Heat Center



LOCATION

The Klamath County Vandenberg Road Complex is located on the eastern edge of Klamath Falls in south central Oregon. Elevation at Klamath Falls is approximately 4,100 ft and the climate is characterized by an annual total of 6,500 heating degree days. The complex is on a hill top about 100 ft higher than the surrounding terrain and originally, somewhat isolated but some residential and businesses are recently developing nearby.

RESOURCE

The complex well produces from the same aquifer as most of the other 550 wells in Klamath Falls. Geothermal water issues from northwest trending faults bordering the east side of town. Water flows in a generally southwest direction from the major faults cooling and mixing with surface water as it proceeds. Temperatures reach a maximum of 220°F nearest the fault. At 151°F, the well serving the complex is 10 - 15°F warmer than nearby wells, but it is also deeper. Water chemistry is relatively benign with pH of about 8 and total dissolved solids of 800 - 1,000 ppm. Isolation heat exchangers are typically used since the water contains approximately 0.5 ppm hydrogen sulphide.

The county complex utilizes one production well 1,400 ft deep. The original pump test produced 760 gpm of 151°F water with a drawdown of 38 ft. A note on the pump test report reads "Well is capable of pumping more water. We need a larger test pump."

Water is injected into a 1,154-ft deep well that tested 210 gpm at 134°F with no measurable drawdown.

UTILIZATION

The history of the complex is somewhat sketchy. Some of the drawings and most of the mechanical specifications for the buildings kept by the county were lost or misplaced after the September 1993 6.0 earthquake. County building and engineering departments were moved and split up several times because their offices were badly damaged and temporary offices were utilized.

Work at the site started on August 10, 1960, when a cable tool well drilling rig was moved in. The well, now the injection well above, was completed as a production well at 1,154 ft on June 10, 1961. A second well, the original injection well, was completed in October 1962 at 205 ft and accepted 75 gpm with water level raising from 130 ft to 82 ft below the casing top.

The Juvenile Detention Home, located near the wells, was the first building at 18,300 sq ft. It was occupied in late-1962. The home had radiant floor heating and domestic hot water supplied by tube-and-shell heat exchangers. The well was equipped with a 7 ½-hp 88-gpm submersible pump set at 150 ft.

In 1954, the County Health Department building, about 5,500 sq ft, now the County Sheriffs Office, was occupied. The building had two heating air handlers (no cooling) supplied from a hot water boiler, probably oil-fired. About 1974, the Mental Health building at 3,880 sq ft was built. The heating system is believed to have been one or more oil-fired forced-air furnaces. About the same time, there was a small, about 600 sq ft, addition to the Juvenile Detention Home. Heating was by radiant floor utilizing the existing system.

In 1979, the Oregon State University County Agriculture Extension Office was built. The building was 8,440 sq ft, and had eight air-source heat pumps for heating and cooling.

In 1982, drawings for the retrofit of the well house for the Juvenile Home called for replacement of the tube-and-shell heat exchangers with a plate-and-frame exchanger, connection to existing underground insulated piping to the Health Dept., Mental Health and Extension buildings, and the addition of a plate-and-frame exchanger and cooling tower, a four-pipe system. These drawings show a fluid coupling variable-speed drive on the wellhead. It appears that some time earlier, the Juvenile Home radiant floor system had failed and been replaced by four fan coil units, and the County Health, Mental Health and Extension Offices had been converted to geothermally-heated four-pipe heating and cooling system. It is believed the fluid coupling and motor were 25-hp, but no records could be found.

In 1988, the new well for the then proposed County Jail was completed (above) at 1,400 ft and 151°F. The well was located off the hill and nearer known higher temperature wells, but does require about 100 ft of lift from the well to the buildings, about 200 ft total lift at current flow rates (100 ft pumping level).

The County Jail, 42,600 sq ft, was completed in 1990. The production well serving the Juvenile Home, County Health, Mental Health and Extension Offices converted to an injection well and the entire complex supplied from the new well. The system schematic is shown. Flows shown are peak design from drawings and are probably never that high. The jail has six fan coils, reheat boxes and unit heaters supplied from a main stainless steel plate heat exchanger. A separate heat exchanger supplies hot water for showers, kitchen, laundry, etc.

The Community Corrections Center, 19,500 sq ft, was occupied in 2003. The heating is provided by two large air handlers with hot water coils and a number of reheat boxes. The building is supplied from the main heating heat exchanger in the jail's mechanical room.

In January of 2004, a 9,000-sq ft addition to the Juvenile Home was occupied. The heating system utilizes two fan coils and reheat boxes supplied from the heat exchanger outside the home.

Currently, the total building area is just under 100,000 sq ft with future additions in planning stages. The design peak load is unknown; since, most of the specifications are not available, but is estimated at approximately 5.6 million Btu/hr plus domestic hot water. A totalizing flow meter indicates the average flow for the year of 207 gpm. The pump motor is on a variable-frequency speed control, but the control system is not yet completed so it is on manual control. There are, however, flow control valves at the mechanical room responding to heating requirements. Monthly average flows vary from a high of 325 gpm down to 116 gpm.

OPERATING AND MAINTENANCE COSTS

Practically nothing is known about operating and maintenance prior to the current maintenance staff, about 10

years. It is believed the submersible 7 ½-hp pump was repaired or replaced at least once, perhaps twice. The 25-hp variable-speed drive and pump were probably never repaired or replaced, but their life is unknown.

The existing heat exchangers in the jail mechanical room were cleaned about 1995 when it was noted that the pressure drop across the exchangers had increased. At that time, corrosion products from the well were found in the exchangers geothermal side. There was also some scale buildup on the clean water side assumed to be from lack of corrosion/scale inhibitors in the closed loop. Shortly thereafter, pressure drop across the exchangers began to increase again and it was apparent the pump needed to be pulled and repaired. It was also obvious that the 120-hp motor, variable-speed fluid drive and 12-in. pump bowls were oversized for the existing load; so, it was decided to replace them with a smaller pump and variable-frequency drive.

On pulling the pump, it was found that about 100 ft of pump column was corroded. The 120 ft below the pumping water level and the pump were in good shape.

In August of 1997, the pump was replaced by a 9LA 14-stage pump with 9-in. bowls, 100 ft of new column, new shaft, oil tube and bearings, and a 60-hp motor with variable-frequency speed control. Although the shaft, oil tube and bearings were in good condition, the new pump required a smaller shaft; so, the assembly was replaced. The pump was salvaged and put in service without repair in an irrigation well, where it remains today. Total cost was \$37,492.50.

At the same time, the jail mechanical room heat exchangers were cleaned and new gaskets installed. Total cost was \$2,300. The exchangers are currently (February 2004) in good condition with no leaks.

As noted above, the DDC controls for the jail have not been completed; so, the pump is on manual speed control at about 40% speed. Immediately after the new pump was installed, total power costs for the jail were over \$1,000 less per month. Since there were no other changes, it was attributed to the pump—a simple payback of less than three years.

At the time the pump was installed, an electricity meter was installed on the pump with the thought of charging individual buildings a share of pumping costs based on building size. This never occurred; however, the use was recorded over 19 months, August 1997 - March 1999. At current electricity cost, the average cost per month would be \$953.

Totaling the gallons pumped for the same months (albeit different years) and assuming a temperature drop of 30°F, the cost of natural gas replaced by geothermal would be \$18,500 per month.

REGULATORY/ENVIRONMENTAL ISSUES

There have been no problems. Drilling low-temperature geothermal production and injection wells in Oregon requires only a start card and completion report (depth, lithology, water bearing zones, casings); unless, it is in a critical water area. The system was designed to meet the city ordinance geothermal injection requirement.

PROBLEMS AND SOLUTIONS

Aside from the oversized pump and corrosion of the pump column noted above, the only problems have been with the outdated pneumatic controls. These are being converted to DDC also as noted.

The system has operated without any major problems for some 40 years and grown over 5 ½ times the original size, while changing system configuration as growth required. Currently, the system is saving \$210,000 in operating cost per year.

CONCLUSIONS AND RECOMMENDATIONS

The original 120-hp pump was grossly oversized. It was sized either based on the maximum well capacity or plans to greatly expand the facilities, which never came to fruition.

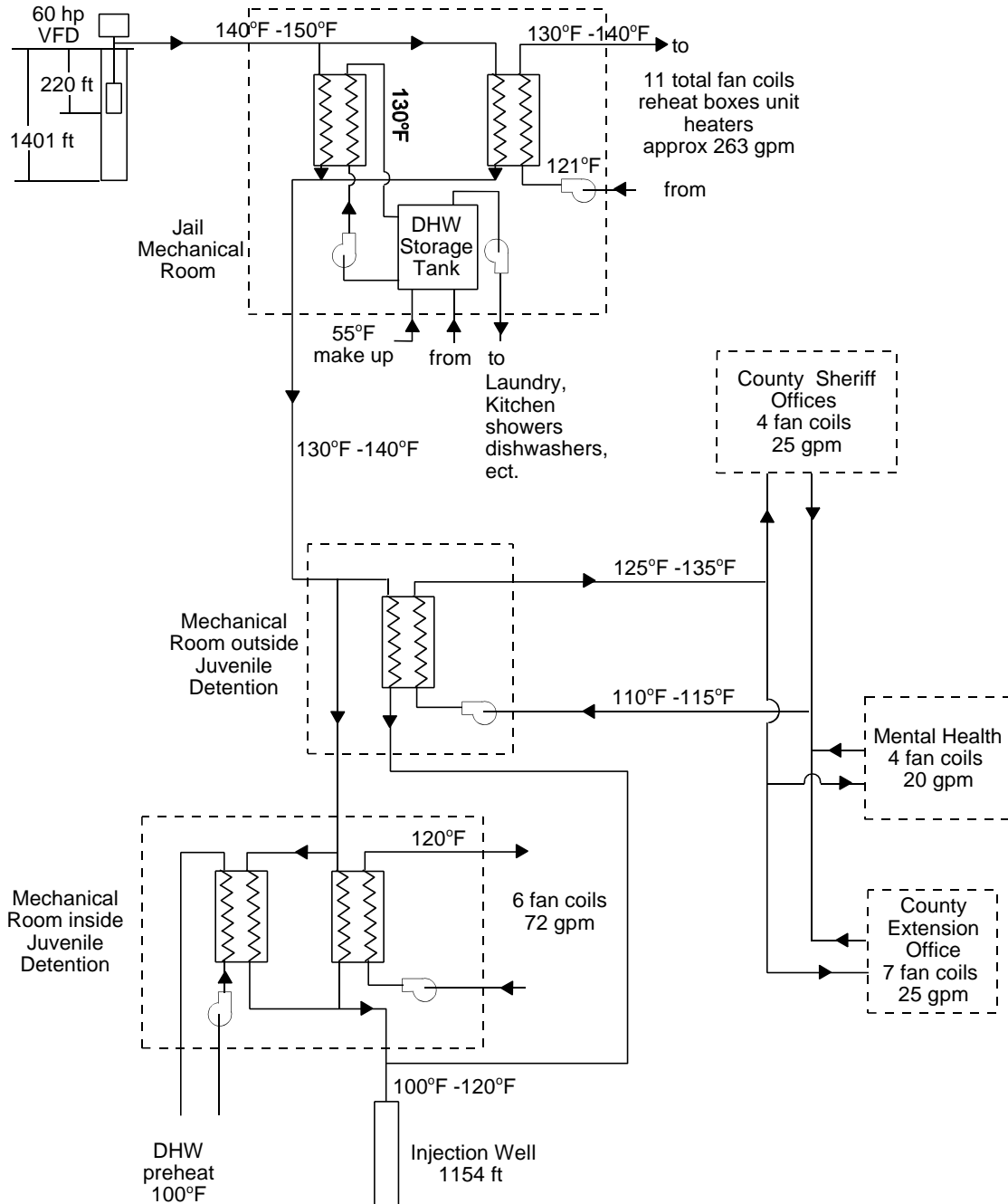

REACH, INC. JUNIPER PROCESSING PLANT KLAMATH FALLS, OREGON

Tonya L. Boyd
Geo-Heat Center



LOCATION

REACH (Rehabilitation, Employment and Community Housing) Inc. (in the building formerly occupied by Maywood, Inc.) is located just outside the Klamath Falls city limits. REACH is a non-profit organization which has found a niche in the specialty area of the selective and environmentally-friendly removal of juniper and also finding uses for the entire tree. They are currently planning on expanding operations in the building such as adding two drying kilns. The 110,000 sq ft building was constructed in 1976. REACH has been in the building since 1993 and incorporates vocational-rehabilitation programs with their workforce. About a third of their gross income is from mill work and a third from the juniper products.

RESOURCE

Klamath Falls is located on the western edge of the Basin and Range Physiographic province, and is situated in a graben structure. Geothermal waters upwell along faults to the northeast as high as 220°F and then flow down gradient to the southwest. REACH is located in this outflow zone where the water is cooler.

REACH is served by a single production well, 1520 ft deep, which had a temperature of 118°F when drilled. The well was pump tested at a flow of 320 gpm with a 115 ft drawdown. The maximum flow rate for the pump is 535 gpm. This is the lowest temperature well in Klamath Falls for direct-use. The well is currently producing at 105°F.

UTILIZATION

The well located adjacent to the building has a 75 hp motor running a lineshaft pump. The system is operated from approximately October to April, 24 hours a day. The original system was designed by Balzhiser and Colvin Engineering with nine air handling units (378,000 Btu/hr) and four make-up air handlers (1,856,000 Btu/hr). Because Maywood had a large number of machines with high air volume dust collectors, a large amount of make-up air was required. The nine air handling units have a four-pass coil system (106" x 27", 14 fins/in) and the four make-up air handlers have an eight-pass coil system (83" x 30", 14 fins/in). There have been two smaller HVAC systems installed for the office and a small fan coil unit installed in the shaver room that has been added to the building. The system was installed with pneumatic controls.

The geothermal water is run directly through the system. The system currently utilizes only four air handlers since REACH has fewer machines generating less dust; so, the make-up air heaters are not required. The two office units and the fan coil unit are being used at this time. The water enters the system at about 105°F and is then discharged to a drainage ditch at 95°F. The drainage ditch combines with the Klamath County Maintenance shop geothermal discharge water which will end up in Lake Ewana. The system has a parallel flow with supply and return lines.

OPERATING COSTS

There are several costs associated with operating the system: 1) city water used to cool the oil in the fluid coupling system, 2) maintenance of the pump and replacing of the coils in the system, and 3) electricity to run the pumps. The costs for the water and electricity are not separated out for the system, but an estimate can be made.

They use about 114,100 ft³ of water per heating season for cooling the oil in the fluid coupling system which has an annual cost of about \$970. They use approximately on average 1000 kWh/day of electricity more during the heating season, which could be attributed to the running of the pump. If the system is run for eight months out of the year, we can assume they use 240,000 kWh for the heating system for a cost of \$16,000. The cost of the electricity is approximately \$.07/kWh. The total operating cost for the system is, therefore, almost \$17,000.

They replace either one or two coils a year with cost of about \$6,000 per coil including labor. This would make a maintenance cost average of \$9,000 per year.

It has been estimated that the well pump has been pulled twice since it was first installed. The impellers were replaced at a cost of \$12,000, but there is no information about additional repairs at those times.

REGULATORY/ENVIRONMENTAL ISSUES

Since the system is located outside the city limits of Klamath Falls, REACH is not required to reinject the geothermal fluid after use. The geothermal is surface disposed of to a ditch which combines with the County Maintenance discharge, which then flows to Lake Ewana

They obtained an Industrial Geothermal Permit in January 2004 from the Department of Environmental Quality (DEQ). This permit authorizes them to discharge their spent geothermal fluids into the waters of the state while they are in compliance with all the requirements, limitations, and conditions set forth in the permit. The parameters and limitations they must meet are:

Flow	shall not exceed the natural geothermal source flow
Temperature	shall not exceed the geothermal source temperature
pH	shall be between 6.0 - 9.0
Other Pollutants	no biocides or water treatment chemicals shall be discharged

All of these measurements are to be taken monthly and a report submitted at the end of the calendar year to DEQ.

PROBLEMS AND SOLUTIONS

Since they are using the geothermal water directly in the system, this has been causing corrosion problems in the coils. They run the system at 20 psi for that is all the pressure the coils can handle without leaking. When REACH bought the building, there were replacement coils left in the building; thus, they have not bought any new coils since they started operation in the building. Due to the corrosion of the coils, they are only running 3 or 4 heaters at a time. They do not use the make-up air handlers as the coils will clog very rapidly. The pneumatic controls are also not working on the system.

Switching to a smaller variable-frequency pump (\$36,000) with DDC system controls (\$13,000) would greatly increase the efficiency of the system. The corrosion in the coils can be eliminated by placing a plate heat exchanger (\$7,500) in the system as the geothermal water enters the building. This would allow clean city water to be run through the coils instead of the more corrosive geothermal water. This would mean that all the coils (9) should be replaced at the time the heat exchanger is installed. This would extend the life of the coils. They are looking into to ways to make the heating system more efficient.

Since the well is only cased for the first 600 feet, it appears that some sloughing has occurred near the bottom, as the temperature has dropped from 118°F to 105°F.

CONCLUSIONS

The system seems to be supplying adequately heat to the building, as the workforce only needs about 60°F room temperature. However, an overhaul of the system including cleaning the well, appears to be necessary to make efficient use of the resource.

The present installed capacity is about 0.5 MWt, utilizing 8.2 billion Btu/yr at a savings of \$75,000/yr (compared to natural gas).

REFERENCES

Lienau, Paul, 1976. "Maywood Industries of Oregon uses 118°F Well for Heating," *Geo-Heat Center Quarterly Bulletin*, Vol. 2, No. 2, p 3-4.

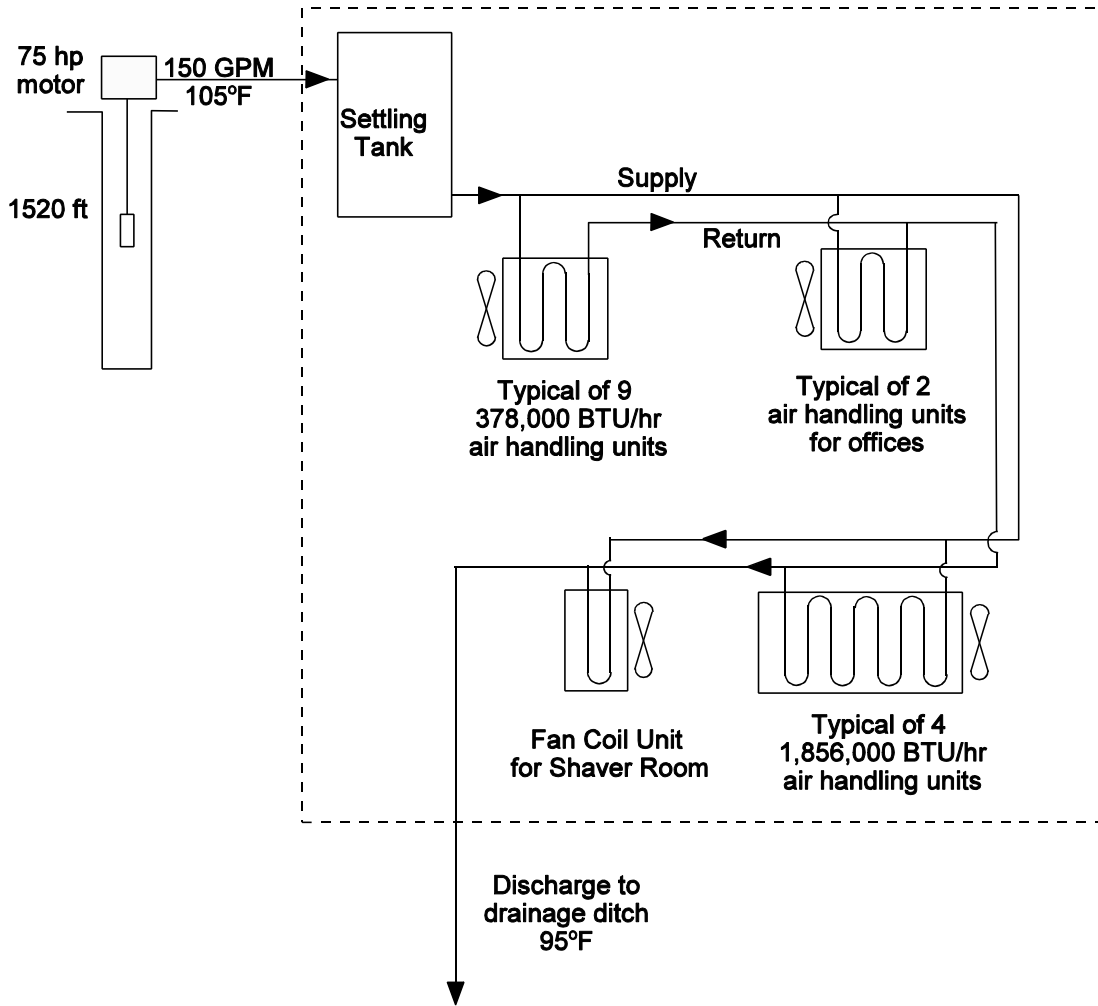

INN OF THE SEVENTH MOUNTAIN BEND, OREGON

Dr. R. Gordon Bloomquist, Ph.D.,
Washington State University Energy Program



BUILDING CHARACTERISTICS

The Inn of the Seventh Mountain is a hotel/condominium complex located approximately seven miles (11 km) from Bend, Oregon, on the road to the Mt. Bachelor ski area, about 175 miles (280 km) south of Portland. The Inn was first built in 1972, and consists of 22 individual condo buildings containing 350 units for a total of 248,800 ft² (23,115 m²). The complex contains restaurants, a conference center, ice rink, spa, and other amenities common to a first-class destination resort. The complex is of wood construction. Heat was originally provided with resistance electric ceiling heat. Most of the lodging units are three stories. The buildings were built to meet the energy codes of the early 1970s, and according to operation staff under insulated. Windows are all double-paned.

GEOHERMAL HEAT PUMP SYSTEM CHARACTERISTICS

A process schematic is shown in Figure 1.

Geothermal Source Description

The geothermal source is provided by one well located close to the central heat pump plant. Water flow is 1,150 gpm (72.5 L/s) at 50°F (10°C). The production well is 400 ft (122 m) deep. Pumping is provided by a 225-hp (168 kW) variable speed pump. After passing through heat exchangers (Figure 2), the water is disposed of through an injection well located near the edge of the property.

Heating, Ventilation, and Air Condition (HVAC) System Description

The central heat pump system consists of two 250-ton (879-kW) screw compressor heat pump chillers (Figure 3). Originally, when the retrofit to heat pumps took place in 1992, one 300-ton (1053 kW) centrifugal unit was installed but, because it was oversized, it continued to surge and would not stay on-line. The two 250-ton (879-kW) screw compressors have proven to be much more satisfactory. The heat pump chillers are separated from the geothermal source through the use of two plate and frame heat exchangers. Distribution of hot [ca 115°F (46°C)] or chilled [50°F (10°C)] water is via a four-pipe distribution system. The distribution system is centrally controlled for optimum temperature balance and energy use. The four-pipe system supplies fan coil units distributed throughout the condo units and other buildings. Hot water from the distribution system also preheats the domestic hot water supply to buildings. The swimming pool, spa tubs, and the bath house are also heated by the heating loop. The chilled water loop serves as the condenser water for the ice ring.

SELECTION OF THE GEOHERMAL HEAT PUMP SYSTEM

By the late 1980s, the 1972 complex was beginning to experience problems with the ceiling electric resistance heating units, and there was an increasing need to be able to provide air conditioning during the summer months. The owners first looked at replacing the system with gas heating and gas absorption cooling. The servicing electric utility,

however, recommended the geothermal heat pump option as a means to meet both heating and air conditioning requirements and provided incentives to the owners. The conversion was made at an investment of ca \$3 million. The conversion project resulted in a 49 percent savings in metered energy, but only a 3 percent savings in energy costs. However, it must be remembered that the system now also provides air conditioning that was not provided by the system replacement.

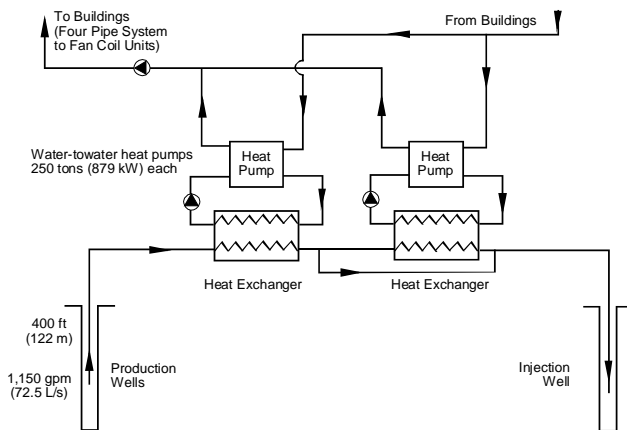

Figure 1. The process schematic for the Inn of the Seventh Mountain.



Figure 2. Photograph of one plate and frame heat exchanger at the Inn of the Seventh Mountain.

OPERATING HISTORY

When the conversion from electric ceiling resistance units to a central geothermal heat pump system was made, the decision was made to go with one 300-ton (1053 kW) centrifugal heat pump/chiller. This, however,

proved to be a poor choice, and during light loads, the unit was considerably oversized and continued to surge and would not stay on-line. After only a short period of time, it was decided to replace the 300-ton (1053 kW) centrifugal unit with two 250-ton (879 kW) screw compressor units. These units also suffered some initial problems due to faulty thrust bearings, and both motor assemblies had to be replaced within the first year. However, after these initial design and equipment problems, the system has operated as expected and with minimal operational or maintenance problems.



Figure 3. Photograph of one of the water-to-water heat pumps at the Inn of the Seventh Mountain.

The only short coming of the system is that there is no central control over thermostats in individual condo units, thus when units are not occupied, there is no way to monitor or control temperature levels. This has resulted in many unoccupied units being heated or cooled needlessly and, of course, with a substantial waste of energy and with a significant cost penalty.

OPERATION AND MAINTENANCE

The system has operated extremely well since initial problems associated with the centrifugal heat pump/chiller and motor thrust bearings were solved. In neither case was the problem a result of or caused by the geothermal source. Maintenance and operation are both taken care of by an experienced and very competent in-house staff.

SYSTEM ECONOMICS

The \$3 million retrofit to geothermal heat pumps resulted in a 49 percent reduction in metered electrical energy consumption, and a 3 percent reduction in overall energy cost, while at the same time providing air conditioning. The total energy consumption for the facility is 24.47 kWh/ft²/yr (263.4 kWh/m²/yr), while the heat pump plant uses 10.14 kWh/ft²/yr (109.1 kWh/m²/yr). Annual maintenance cost for the past several years have averaged approximately \$0.18/ft² (\$1.94/m²). The annual energy usage as well as the maintenance cost is somewhat of an over estimate, as the system also provides heating to two

swimming pools and the spa pools, and the chilled water loop serves as the condenser water for the ice ring.

SATISFACTION WITH THE GEOTHERMAL HEAT PUMP SYSTEM

Operation and maintenance staff are both extremely happy with how the system has operated and the lack of maintenance problems that have occurred. The system seems to provide a high level of comfort to guests. It would appear that even greater energy and cost savings would be possible if the system were set up so that individual units could be monitored and thermostats adjusted when the units were unoccupied for any extended length of time.

ACKNOWLEDGEMENT

The author wishes to thank Jon Menzic, the director of facilities for the Inn of the Seventh Mountain and Clark Satrae of Pacific Power and Light for their assistance in obtaining data.

OVERALL SUMMARY

Building Description:

Location: Bend, OR

Occupancy: Hotel/condominium resort

Gross Floor Area: 248,800 ft² (23,115 m²), 22 buildings

Type of Construction: Retrofit

Completion Date: Buildings in 1972, heat pump retrofit in 1992

July Avg. High Temp.: 81.7°F (27.2°C)

Jan Avg. Low Temp.: 23°F (-5.0°C)

Annual Heating Degree Days: 4490°F-day (2494°C-day)

Annual Cooling Degree Days: 12°F-day (7°C-day)

Interior System:

Total Installed Heat Pump Capacity: 500 tons (1758 kW)

No. of Heat Pump Units: 2 water-to-water

Heat Pump Capacities: 250 tons (879 kW)

Ground-Source System:

Type: Open loop

Mean Groundwater Temp.: 50°F (10°C)

Configuration: 1 production well, 1 injection well

Well Depths: 400 ft (122 m)

Pumping Rates: 1,150 gpm (72.5 L/s)

Economic Analysis:

Installed Geothermal HVAC Capital Cost:

\$3 million

Total Annual HVAC Energy Use:

10.14 kWh/ft² (109.1 kWh/m²)

Total Annual HVAC Energy Savings:

49% plus the additional benefit of cooling

Annual Maintenance Costs:

\$0.18/ft² (\$1.94/m²)



GEO-HEAT CENTER
Oregon Institute of Technology
Klamath Falls, Oregon 97601-8801

Nonprofit Organization
U.S. Postage
PAID
Klamath Falls, OR 97601
Permit No. 45



Geothermal Technologies Program Oregon



Oregon's geothermal potential is third only to that of Nevada and California. Almost the entire state east of the Cascade range has ample low- to mid-temperature geothermal resources for direct-heat applications. This is especially true of the south and southeastern portions of the state. As a result, Oregon has about 2,200 thermal wells and springs that furnish churches, schools, homes, communities, businesses, and facilities with 500 to 600 billion Btus of energy per year.

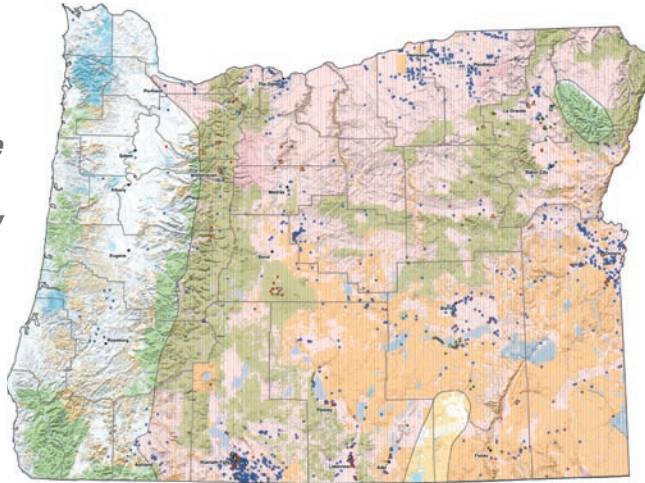

In Klamath Falls, Oregon, a geothermal district heating system keeps the sidewalks clear and dry at the Basin Transit Station after a snowfall.

Although Oregon currently generates no geothermal electricity, it has about a dozen areas that are known to be able to produce electricity, seven of which have been designated as prime areas for exploration. All told, the state's high-temperature geothermal areas have the potential for about 2,200 megawatts (MW) of electric power.

Current Development

Oregonians have been tapping into their low-to-moderate temperature geothermal resource for more than a century to heat buildings, grow plants in greenhouses, heat water for fish farming, melt snow from sidewalks and roads, and for other applications.

In Klamath Falls, for example, there are 550 geothermal wells that provide heat for as many as 1,000 homes. The city itself exploits the geothermal resource for a district heating system that provides heat for more than 25 churches, government and commercial buildings, and for melting snow from sidewalks.

One of the latest customers for the Klamath Falls district-heating system is a greenhouse complex run by IFA Nurseries, Inc. This complex has two 50,000 square-foot (ft²) greenhouses that can raise 4 million seedlings of ponderosa pine, hemlock, and other tree species.

There are four other geothermally heated greenhouses in Oregon that raise vegetables, potted plants, and tree seedlings. Plus, there are more than 50 other direct-use sites in the state with applications that range from heating a college campus to raising mushrooms.

Economic Benefits

By using geothermal energy instead of natural gas, Oregon customers typically save between 40% and 60% on their energy bills.

Specific examples of savings include:

- The Oregon Institute of Technology in Klamath Falls, which uses geothermal energy to heat almost 100% of its 600,000 ft² of buildings to save \$300,000 per year
- The Merle West Medical Center in Klamath Falls, which uses geothermal energy to heat 480,00 ft² of buildings and to melt snow off sidewalks to save \$180,000 annually

A Strong Energy Portfolio for a Strong America

Energy efficiency and clean, renewable energy will mean a stronger economy, a cleaner environment, and greater energy independence for America. Working with a wide array of state, community, industry, and university partners, the U.S. Department of Energy's Office of Energy Efficiency and Renewable Energy invests in a diverse portfolio of energy technologies.



History

In the late 1800s, recreational spas were developed in the eastern United States and in several western states. In Oregon, the first large-scale use of geothermal springs came with the construction in 1864 of the Hot Springs Sanatorium, near La Grande.

In Klamath Falls, the use of geothermal energy for heating began around 1900 when several homes were heated using the artesian flow from local hot springs. After 1911, the Butler Natatorium opened. And in 1929 the first down-hole heat exchanger was installed. (This is a heat exchanger that eliminates the need to pump water from wells to heat homes and other applications, thus conserving the resource.)

Development expanded greatly in the 1920s and 1930s when the Klamath Union High School was built to use geothermal energy for heating. Development continued in the 1940s when the first highway de-icing system was installed on Esplanade Street in Klamath Falls. In 1964 the new Oregon Institute of Technology campus was built to depend exclusively on geothermal water for heating.

The city of Klamath Falls initiated the building of its district heating system in 1981. Originally intended to serve 14 government buildings, the system has since increased its customer base substantially. (See also the information on Klamath Falls on the first page of this fact sheet.)

In addition to Klamath Falls, more than 30 other communities have been developing systems to use geothermal heat, including Lakeview, La Grande, Vale, and other eastern Oregon cities. Recently, a handwritten district-heating feasibility study for Lakeview, dated 1911, was discovered. The proposed project was to be patterned after the successful Boise, Idaho, project—then nearly 20 years old.

Manager and field tech show an example of plug seedlings being grown at IFA Nurseries' recently constructed Klamath Falls greenhouse, which is geothermally heated.

- Gone Fishing aquaculture, whose use of geothermal energy avoids 24 million kilowatt-hours of electricity annually, for a savings of \$1,350,000
- The Warner Creek Correctional Center, a 400-bed facility being built in Lakeview, which will use geothermal energy to heat the facility and avoid the use of 180,000 gallons of propane per year, for an annual savings of more than \$100,000.

The economic potential of geothermal energy, however, is far larger than indicated by the current exploitation of low- to mid-temperature geothermal resources. For example, by fully developing its 2,200 MW of electric potential from high-temperature geothermal areas, Oregon could generate approximately 183 billion kilowatt-hours of electricity per year. This is enough electricity to supply about 2 million homes with their electrical needs or nearly 40% of the state's current electricity consumption.

Technical Capabilities

The Northwest is fortunate to be the home of the Geo-Heat Center, which is part of the Oregon Energy Center housed at the Oregon Institute of Technology campus in Klamath Falls. Since 1975, the Geo-Heat Center has provided information research and technical assistance to developers of geothermal energy.



GEOPOWERING THE WEST

GeoPowering the West is a cooperative federal, state, and local effort to promote awareness of the vast geothermal energy resources in the western United States, including Alaska and Hawaii. GeoPowering the West partners with businesses, government officials, Native American groups, utilities, and energy consumers to expand the use of geothermal energy.

For more information contact:

EERE Information Center

1-877-EERE-INF (1-877-337-3463)

eereic@ee.doe.gov or visit: www.eere.energy.gov

Geo-Heat Center

John Lund, Director

Oregon Institute of Technology

(541) 885-1750 or visit: geoheat.oit.edu

Oregon Department of Energy

Carel deWinkel, Carel.Dewinkel@state.or.us

(503) 378-6099 or visit:

www.energy.state.or.us

U.S. Department of Energy Western Regional Office

Curtis Framel, Curtis.Framel@EE.DOE.GOV

(206) 553-7841 or visit:

www.eere.energy.gov/regions/western

U.S. Department of Energy GeoPowering the West

Susan Norwood, National Coordinator

susan.norwood@hq.doe.gov

(202) 586-4779 or visit:

www.eere.energy.gov/geopoweringthewest

Produced for the

U.S. Department of Energy (DOE)

Energy Efficiency and Renewable Energy



U.S. Department of Energy

Energy Efficiency and Renewable Energy

1000 Independence Avenue, SW
Washington, DC 20585

By the National Renewable Energy Laboratory,
a DOE National Laboratory

DOE/GO-102004-2036

February 2005

Printed with a renewable source ink on paper containing at least 50% wastepaper, including 20% postconsumer waste.

Geo-Heat Center Publications for Oregon

Geothermal Direct-Use Engineering and Design Guidebook

Technical Papers on Oregon

Regulatory Issues for Direct-Use Geothermal Resource Development in Oregon

<http://geoheat.oit.edu/pdf/tp114.pdf>

Klamath Falls Geothermal Field, Oregon - Case History of Assessment, Development and Utilization

<http://geoheat.oit.edu/pdf/tp24.pdf>

An Overview of US District Heating Systems

<http://geoheat.oit.edu/pdf/tp46.pdf>

A Materials and Equipment Review of Selected US Geothermal District Heating Systems

<http://geoheat.oit.edu/pdf/he4.pdf>

Doublet Tracer Testing in Klamath Falls, Oregon

<http://geoheat.oit.edu/pdf/tp9.pdf>

Groundwater Characteristics and Corrosion Problems Associated with the Use of Geothermal Water In Klamath Falls, Oregon

<http://geoheat.oit.edu/pdf/hg3.pdf>

Geothermal Research at the Geo-Heat Center

<http://geoheat.oit.edu/pdf/tp85.pdf>

Marketing the Klamath Falls Geothermal District Heating System

<http://geoheat.oit.edu/pdf/tp40.pdf>

Case Histories of Vale, Oregon and Susanville, California

<http://geoheat.oit.edu/pdf/tp4.pdf>

Geothermal Injection Monitoring in Klamath Falls, OR

<http://geoheat.oit.edu/pdf/tp5.pdf>

Geothermal District Heating System - City of Klamath Falls

<http://geoheat.oit.edu/pdf/tp19.pdf>

Bulletin Articles on Oregon

Continuing Advances in PEX Downhole Exchangers for direct-Use Heating Applications (June 2007)

<http://geoheat.oit.edu/bull28-2/art4.pdf>

“Chill Out” - Oregon Institute of Technology is a Winner (June 2007)

<http://geoheat.oit.edu/bulletin/bull28-2/art3.pdf>

Klamath Falls Geothermal District Heating System at 25 Years (June 2007)

<http://geoheat.oit.edu/bulletin/bull28-2/art3.pdf>

GreenFuels of Oregon: Geothermal Energy Utilization in Biodiesel (March 2007)

<http://geoheat.oit.edu/bulletin/bull28-1/art3.pdf>

From Creamery to Brewery with Geothermal Energy: Klamath Basin Brewing Company December 2006)

<http://geoheat.oit.edu/bulletin/bull27-4/art1.pdf>

Geothermal Projects Proposed for the Oregon Institute of Technology Campus (December 2006)

<http://geoheat.oit.edu/bulletin/bull27-4/art6.pdf>

Chiloquin Community Center, Chiloquin, Oregon (September 2005)

<http://geoheat.oit.edu/bulletin/bull26-3/art5.pdf>

Inn of the Seventh Mountain, Bend Oregon (September 2005)

<http://geoheat.oit.edu/bulletin/bull26-3/art8.pdf>

Design and Installation of a new Downhole Heat Exchanger for Direct-use Space Heating (March 2005)

<http://geoheat.oit.edu/bulletin/bull26-1/art6.pdf>

Kah-Nee-Ta Swimming Pool - Warm Springs, Oregon (March 2004)
<http://geoheat.oit.edu/bulletin/bull25-1/art1.pdf>

Klamath County Vandenberg Road Complex (March 2004)
<http://geoheat.oit.edu/bulletin/bull25-1/art2.pdf>

Residential Downhole Heat Exchanger (March 2004)
<http://geoheat.oit.edu/bulletin/bull25-1/art3.pdf>

REACH, Inc. Juniper Processing Plant, Klamath Falls, Oregon (March 2004)
<http://geoheat.oit.edu/bulletin/bull25-1/art4.pdf>

Oregon Trail Mushrooms (March 2004)
<http://geoheat.oit.edu/bulletin/bull25-1.art5.pdf>

New Snow Melt Projects - Klamath Falls, Oregon (September 2003)
<http://geoheat.oit.edu/bulletin/bull24-3/art3.pdf>

Examples of Industrial Uses of Geothermal Energy in the United States (September 2003)
<http://geoheat.oit.edu/bulletin/bull24-3/art1.pdf>

“Gone Fishing” Aquaculture Project, Klamath Falls, Oregon (June 2003)
<http://geoheat.oit.edu/bulletin/bull24-2/art3.pdf>

Merle West Medical Center, Klamath Falls, Oregon (June 2003)
<http://geoheat.oit.edu/bulletin/bull24-2/art4.pdf>

New Geothermal Snow Melt Project in Klamath Falls, OR (March 2003)
<http://geoheat.oit.edu/bulletin/bull24-1/art6.pdf>

Out of Africa - Aquaculturist Ron Barnes Uses Geothermal Water In Southern Oregon to Rear Tropical Fish from African Rift Lake (September 2002)
<http://geoheat.oit.edu/bulletin/bull23-3/art2.pdf>

New Greenhouses in Klamath Falls (September 2002)
<http://geoheat.oit.edu/bulletin/bull23-3/art3.pdf>

A Tribute to Charlie Leib - Grandfather of Klamath Falls Geothermal Development (March 2002)
<http://geoheat.oit.edu/bulletin/bull23-1/art2.pdf>

First GEA/GRC Geothermal Excellence Award (December 2000)
<http://geoheat.oit.edu/bulletin/bull21-4/art1.pdf>

Klamath Falls Geothermal District Heating System Flow and Energy Metering (June 2000)
<http://geoheat.oit.edu/bulletin/bull21-2/art3.pdf>

Photos of Typical Downhole Heat Exchangers and Heating Systems, Klamath Falls, Oregon (September 1999)
<http://geoheat.oit.edu/bulletin/bull20-3/art2.pdf>

Information for the Prospective Geothermal Home Buyer (September 1999)
<http://geoheat.oit.edu/bulletin/bull20-3/art3.pdf>

Large Downhole Heat Exchanger in Turkey and Oregon (September 1999)
<http://geoheat.oit.edu/bulletin/bull20-3/art4.pdf>

Examples of Individual Downhole Heat Exchangers Systems in Klamath Falls (September 1999)
<http://geoheat.oit.edu/bulletin/bull20-3/art5.pdf>

Small Geothermal Power Plant Examples (June 1999)
<http://geoheat.oit.edu/bulletin/bull20-2/art2.pdf>

International Geothermal Days - Oregon (March 1999)
<http://geoheat.oit.edu/bulletin/bull20-1/art8.pdf>

Klamath Falls Geothermal District Heating Systems (March 1999)
<http://geoheat.oit.edu/bulletin/bull20-1/art2.pdf>

The Oregon Institute of Technology Geothermal Heating System - Then and Now (March 1999)
<http://geoheat.oit.edu/bulletin/bull20-1/art3.pdf>

Reconstruction of a Pavement Geothermal Deicing System (March 1999)
<http://geoheat.oit.edu/bulletin/bull20-1/art4.pdf>

Love Three Hot Springs Out of the Thousands - Hot Creek, Fields and Ash (March 1999)
<http://geoheat.oit.edu/bull20-1/art5.pdf>

Milk Pasteurization with Geothermal Energy (August 1997)
<http://geoheat.oit.edu/bulletin/bull18-3/art4.pdf>

Geothermal Greenhouse Development Update (January 1997)
<http://geoheat.oit.edu/bulletin/bull18-1/art2.pdf>

Klamath Falls Geothermal District Heating System Evaluation (August 1996)
<http://geoheat.oit.edu/bulletin/bull17-3/art4.pdf>

OIT Geothermal System Improvements (August 1996)
<http://geoheat.oit.edu/bulletin/bull17-3/art5.pdf>

Klamath Falls Snow Melt System (October 1995)
<http://geoheat.oit.edu/bulletin/bull16-4/art4.pdf>

Collocated Resources (October 1995)
<http://geoheat.oit.edu/bulletin/bull16-4/art3.pdf>

Pavement Snow Melting in Klamath Falls - Rehabilitation of the ODOT Well (February 1995)
<http://geoheat.oit.edu/pdf/bulletin/bi074.pdf>

Low-Temperature Geothermal Database for Oregon (November 1994)
<http://geoheat.oit.edu/pdf/bulletin/bi069.pdf>

Agriculture and Aquaculture Cascading the Geothermal Way (November 1994)
<http://geoheat.oit.edu/pdf/bulletin/bi065.pdf>

Low-Temperature Geothermal Resources Assessment - Preliminary Results (March 1994)
<http://geoheat.oit.edu/pdf/bulletin/bi057.pdf>

Groundwater Heat Pump Project - Junction city High School, Oregon (March 1994)
<http://geoheat.oit.edu/pdf/bulletin/bi053.pdf>

Groundwater Anomalies Associated with the Klamath Basin Earthquakes of September 20-24, 1993 (November 1993)
<http://geoheat.oit.edu/pdf/bulletin/bi050.pdf>

Marketing the Klamath Falls Geothermal District Heating System (August 1993)
<http://geoheat.oit.edu/pdf/bulletin/bi044.pdf>

Significant Events in the Development of Geothermal Direct Use in the United States(December 1992)
<http://geoheat.oit.edu/pdf/bulletin/bi033.pdf>

Geothermal District Heating System - City of Klamath Falls (August 91)
<http://geoheat.oit.edu/pdf/bulletin/bi025.pdf>

Hot Spots for Cold Fish: Geo-Heat Center Participates in Aquaculture Research (April 1991)
<http://geoheat.oit.edu/pdf/bulletin/bi020.pdf>

Geothermal Greenhouse Development (Spring 1990)
<http://geoheat.oit.edu/pdf/bulletin/bi006.pdf>

General Papers

Aquaculture Information Package
<http://geoheat.oit.edu/pdf/aqua.pdf>

Geothermal Greenhouse Information Package
<http://geoheat.oit.edu/pdf/green.pdf>

Direct Heat Utilization of Geothermal Resources
<http://geoheat.oit.edu/pdf/directht.pdf>

Pavement Snow Melting
<http://geoheat.oit.edu/pdf/tp108.pdf>

Valuation of Geothermal Wells on Real Property
<http://geoheat.oit.edu/pdf/tp111.pdf>

Balneological Use of Thermal Waters
<http://geoheat.oit.edu/pdf/tp109.pdf>

Small Geothermal Systems: A Guide for the Do-It-Yourselfer

<http://geoheat.oit.edu/pdf/tp105.pdf>

Geothermal Power Generation - A Primer on Low-Temperature, Small-Scale Applications

<http://geoheat.oit.edu/pdf/powergen.pdf>

An Information Survival Kit for the Prospective Geothermal Heat Pump Owner

<http://geoheat.oit.edu/ghp/survival.pdf>

A Guide to On-line Geological Information and Publications for Use in GSHP Site Characterization

<http://geoheat.oit.edu/otl/guidegshp.pdf>

Data Acquisition for Low-Temperature Geothermal Well Tests and Long-Term Monitoring

<http://geoheat.oit.edu/pdf/tp17.pdf>

Aquaculture and Geothermal Heat Pumps

<http://geoheat.oit.edu/pdf/tp116.pdf>

Residential Swimming Pool Heating with Geothermal Heat Pump Systems

<http://geoheat.oit.edu/pdf/tp117.pdf>

Greenhouse Heating with Geothermal Heat Pump Systems

<http://geoheat.oit.edu/pdf/tp118.pdf>

General Bulletin Articles

Characteristics, Development and Utilization of Geothermal Resources (June 2007)

<http://geoheat.oit.edu/bulletin/bull28-2/art1.pdf>

Geothermal Energy Utilization in Ethanol Production (March 2007)

<http://geoheat.oit.edu/bulletin/bull28-1/art2.pdf>

Integrating Small Power Plants into Direct-Use Projects (June 2005)

<http://geoheat.oit.edu/bulletin/bull26-2/art2.pdf>

Fish Rearing Ponds Cascaded from Binary Power Generation (March 2005)

<http://geoheat.oit.edu/bulletin/bull26-1/art5.pdf>

Geothermal Websites (March 2005)

<http://geoheat.oit.edu/bulletin/bull26-1/art8.pdf>

Direct-Use Temperature Requirements: A Few Rules of Thumb (June 2004)

<http://geoheat.oit.edu/bulletin/bull25-2/art1.pdf>

Industrial Process and the Potential for Geothermal Applications (September 2003)

<http://geoheat.oit.edu/bulletin/bull24-3/art2.pdf>

Western States Geothermal Database CD (March 2002)

<http://geoheat.oit.edu/bull23-1/art1.pdf>

Geothermal Direct-Use in the United States (March 2000)

<http://geoheat.oit.edu/bull21-1/art1.pdf>

Small Geothermal Power Plants: Design, Performance and Economics (June 1999)

<http://geoheat.oit.edu/bulletin/bull20-2/art1.pdf>

Opportunities for Small Geothermal Power Projects (June 1999)

<http://geoheat.oit.edu/bulletin/bull20-2/art3.pdf>

Geothermal Direct-Use Equipment Overview (March 1998)

<http://geoheat.oit.edu/bulletin/bull19-1/art1.pdf>

Onion Dehydration (July 1994)

<http://geoheat.oit.edu/pdf/bulletin/bi060.pdf>

Heap Leaching (Spring 1990)

<http://geoheat.oit.edu/pdf/bulletin/bi007.pdf>

Other Publications from other websites

Geothermal-Biz.com

Geothermal Small Business Workbook

<http://www.geothermal-biz.com/GSBW.pdf>

Geothermal Money Book

<http://www.geothermal-biz.com/GeoMoneyBook.pdf>

Geothermal Literature Assessment: Environmental Issues

<http://www.geothermal-biz.com/GeothermalLiterature.pdf>

Washington State University Energy Office

A Regulatory Guide to Geothermal Direct Use Development

<http://www.energy.wsu.edu/ftp-ep/pubs/renewables/oregon.pdf>

National Renewable Energy Laboratory (NREL)

Buried Treasure: The Environmental, Economic, and Employment Benefits of Geothermal Energy

<http://www.nrel.gov/docs/fy04osti/35939.pdf>

Geothermal Technologies Program: Direct Use

<http://www.nrel.gov/docs/fy04osti/36316.pdf>

Geothermal Technologies Program: Enhanced Geothermal Systems

<http://www.nrel.gov/docs/fy04osti/36317.pdf>

Energy and Geoscience Institute

Geothermal Energy Clean Sustainable Energy for the Benefit Humanity and the Environment (Red Brochure)

<http://egi-geothermal.org/GeothermalBrochure.pdf>

Geothermal Education Office

The Geothermal Education Office (GEO) produces and distributes educational materials about geothermal energy to schools, energy/environmental educators, libraries, industry, and the public. GEO collaborates frequently with education and energy organizations with common goals, and, through its website, responds to requests and questions from around the world.

<http://geothermal.marin.org>

Stoel Rives LLP,

Developed a guide containing insights that the law firm's multi-state Geothermal Team has gained over the past ten years serving the U.S. geothermal industry domestically and abroad. Lava Law describes the current legal and policy issues most likely to affect the geothermal industry in general, and the development of individual geothermal projects.

http://www.stoel.com/webfiles/LAVA_Web_2007.pdf